

4-Port USB 2.0 Hub

User Manual | HUB4PH



SEALEVEL®

Contents

- CONTENTS 2
- SAFETY INSTRUCTIONS..... 3
- INTRODUCTION..... 4
- BEFORE YOU GET STARTED..... 6
- INSTALLATION..... 14
- HARDWARE DESCRIPTION..... 15
- SEALATCH® USB..... 19
- TECHNICAL SPECIFICATIONS 21
- APPENDIX A – TROUBLESHOOTING 23
- APPENDIX B – HOW TO GET ASSISTANCE 24
- APPENDIX C – SILK SCREEN – HUB4PH PCB..... 25
- APPENDIX D– COMPLIANCE NOTICES..... 26
- WARRANTY..... 27

Safety Instructions

Electrostatic Discharges (ESD)

A sudden electrostatic discharge can destroy sensitive components. Proper packaging and earthing rules must therefore be observed. Always take the following precautions.

- Transport boards and cards in electrostatically secure containers or bags.
- Keep electrostatically sensitive components in their containers, until they arrive at an electrostatically protected workplace.
- Only touch electrostatically sensitive components when you are properly earthed.
- Store electrostatically sensitive components in protective packaging or on anti-static mats.

Grounding Methods

The following measures help to avoid electrostatic damages to the device:

- Cover workstations with approved antistatic material. Always wear a wrist strap connected to workplace as well as properly grounded tools and equipment.
- Use antistatic mats, heel straps, or air ionizers for more protection.
- Always handle electrostatically sensitive components by their edge or by their casing.
- Avoid contact with pins, leads, or circuitry.
- Turn off power and input signals before inserting and removing connectors or connecting test equipment.
- Keep work area free of non-conductive materials such as ordinary plastic assembly aids and Styrofoam.
- Use field service tools such as cutters, screwdrivers, and vacuum cleaners which are conductive.
- Always place drives and boards PCB-assembly-side down on the foam.

Introduction

With industrial and OEM applications increasingly adding USB devices, the need for more USB ports becomes a necessity. The HUB4PH is a powered USB 2.0 4-port hub that is perfect for adding high-speed USB ports to industrial computing platforms.

The HUB4PH adds support for the USB 2.0 Battery Charging Specification version BC1.2 by the addition of a single Charging Downstream Port (CDP). The remaining three ports are Standard Downstream Ports (SDP).

USB 2.0 Standard Downstream Port (SDP)

An SDP is a traditional USB 2.0 port that provides for data communications as well as a minimum of 500mA of power. The host controller must be active to allow charging and the attached device will charge at a slower rate due to the limited power available.

USB 2.0 Charging Downstream Port (CDP)

A CDP is a USB 2.0 port that provides for data communications and has the enhanced capability to provide up to 1.5A to the attached downstream device. For devices compatible with the USB Battery Charging BC1.2 specification a handshaking process occurs during attachment that allows the device to determine the amount of power available. Once a CDP port is detected the device is then aware that extra power is available and can be used to charge the device faster and at a higher rate.

The HUB4PH is USB 2.0 compliant, providing a full 480M bps data rate to the host, and is backwards compatible with USB 1.1 and 1.0 devices. Additionally, port one is configured as a USB Battery Charging Specification BC1.2 Compliant Charging Downstream Port (CDP) supplying up to 1.5A of current. The powered hub includes a wall-mount AC adapter that supplies 1.5A to port 1 and a full 500mA to ports 2 through 4. The hub is housed in a rugged plastic enclosure and a status LED indicates proper connection to the host.

Additionally, the HUB4PH-KT and HUB4PH-OEM versions both include a power cable that sources +5VDC power from a standard hard drive connector. For the -KT and -OEM versions all four ports are configured as USB Battery Charging Specification BC1.2 Compliant Charging Downstream Ports (CDP) and supplies a full 1.5A to each attached USB peripheral. The standard operating temperature range is 0°C to 70°C and extended temperature range (-40°C to +85°C) is optional.

INTRODUCTION, CONTINUED

Features

- Includes four powered downstream USB ports
- HUB4PH includes one CDP and three SDP
- –KT and –OEM versions include four CDP's
- Status LED indicates connection to host
- USB 2.0 compliant and backwards compatible with USB 1.1 and 1.0 devices
- Native support in USB aware operating systems including Windows and Linux
- Available in extended temperature versions



Before You Get Started

What's Included – HUB4PH

The HUB4PH is shipped with the following items. If any of these items is missing or damaged, please contact Sealevel for replacement.

- **HUB4PH – Sealevel High Speed 4-Port USB 2.0 Hub**
- **CA356 – USB Type 'A' to SeaLATCH Type 'B' Device Cable, 72" length**
- **TR124 – Wall-mount AC power supply (5VDC @ 4A), locking DC connector**

Advisory Conventions



Warning

The highest level of importance used to stress a condition where damage could result to the product, or the user could suffer serious injury.



Important

The middle level of importance used to highlight information that might not seem obvious or a situation that could cause the product to fail.







Note



The lowest level of importance used to provide background information, additional tips, or other non-critical facts that will not affect the use of the product.

Optional Items – HUB4PH

Depending upon your application, you are likely to find one or more of the following items useful with the HUB4PH. All items can be purchased from our website (<http://www.sealevel.com>) or by calling +1 864-843-4343.

SeaLATCH USB Type A and Type B Device Cable, 72" (Item# CA332)	
<p>The CA332 is a USB device cable with SeaLATCH USB type A and type B connectors. The metal thumbscrew on each connector provides a secure metal-to-metal connection to devices with SeaLATCH USB ports.</p>	
SeaLATCH USB Type A to USB Type B Device Cable, 72" (Item# CA355)	
<p>The CA355 is a USB device cable with a SeaLATCH USB type A connector and standard type B connector. This cable secures the hub to legacy USB peripheral devices.</p>	
USB Type A to SeaLATCH USB Type B Device Cable, 72" (Item# CA356)	
<p>The CA356 is a USB device cable with a SeaLATCH USB type B connector and standard USB Type A connector. This 72" cable is included with all Sealevel USB products with an integrated SeaLATCH USB Type B port.</p>	
USB Type A to USB Type B, 72" Device Cable (Item# CA179)	
<p>The CA179 is a 72" USB device cable that connects USB peripherals with a Type B connector to the Type A connector on a host computer. The CA179 is USB 2.0 compliant and is compatible with USB 1.1 and 1.0 devices.</p>	

OPTIONAL ITEMS – HUB4PH, CONTINUED

USB Type A to USB Type A, 3 meters Extension Cable (Item# CA214)	
<p>The CA214 is a fully rated USB extension cable that allows adding 3 meters (maximum 5 meters) to any existing USB cable. The cable has a Type A male connector on one end and a Type A female connector on the other end.</p>	
USB Type A to USB Type B, 5 meters Device Cable (Item# CA215)	
<p>The CA215 is a fully rated 5-meter device cable that connects USB peripherals with a Type B connector to the Type A connector on a host PC. This cable provides the maximum 5 meters (16 feet) for a USB connection.</p>	
DIN Rail Mounting Clips (Item# DR105)	
<p>The DR105 DIN rail clips mount to the flanges with included pan head screws. The rugged plastic clips securely mount to all common profiles of 35mm DIN rail (i.e., "Top Hat" rail) and are compatible with A-series mounting rails.</p>	

What's Included – HUB4PH-KT

The HUB4PH-KT is shipped with the following items. If any of these items is missing or damaged, please contact Sealevel for replacement.



- **HUB4P-KT – Sealevel iPortholes™ High Speed 4-Port USB 2.0 Hub**
- **CA393 – +5V Internal Power Cable**



OEM models of the HUB4P does not ship with a USB cable. See the available selection of USB cable options below.

Optional Items – HUB4PH-KT

Depending upon your application, you are likely to find one or more of the following items useful with the HUB4PH-KT. All items can be purchased from our website (<http://www.sealevel.com>) or by calling +1 864-843-4343.

Internal USB Cable for Box Header Connectors, 14" (Item# CA469)	
<p>The CA469 is an embedded USB cable that has a 1x5 2mm Molex connector for connecting to Sealevel embedded USB products. The other end of the cable has a 1x5 0.1" (2.54mm) box header connector found on medium to large sized motherboards, including ATX, Micro ATX, Mini ATX, ITX, Mini ITX and EBX form factors. The CA469 is 14" in length and uses one USB port connection on the computer motherboard.</p>	
Internal USB Cable for 1x5 2mm Box Headers, 14" (Item# CA472)	
<p>This cable is perfect for adding Sealevel I/O modules to small embedded systems. One end of the cable has a 1x5 2mm Molex connector for internal connections to Sealevel embedded USB products. The other end of the cable has a 1x5 2mm box header connector found on very small motherboards, including EPIC, 3.5" Biscuit, ETX, Nano ITX, Pico ITX and PC/104 Small Board Computers. The CA472 is 14" in length and uses one USB port connection on the computer motherboard.</p>	

OPTIONAL ITEMS – HUB4PH-KT, CONTINUED

SeaLATCH USB Type A and Type B Device Cable, 72" (Item# CA332)	
<p>The CA332 is a USB device cable with SeaLATCH USB Type A and Type B connectors. The metal thumbscrew on each connector provides a secure metal-to-metal connection to devices with SeaLATCH USB ports.</p>	
SeaLATCH USB Type A to USB Type B Device Cable, 72" (Item# CA355)	
<p>The CA355 is a USB device cable with a SeaLATCH USB Type A connector and standard Type B connector. This cable secures the hub to legacy USB peripheral devices.</p>	
USB Type A to USB Type B, 72" Device Cable (Item# CA179)	
<p>The CA179 is a 72" USB device cable that connects USB peripherals with a Type B connector to the Type A connector on a host computer. The CA179 is USB 2.0 compliant and is compatible with USB 1.1 and 1.0 devices.</p>	

What's Included – HUB4PH-OEM

The **HUB4PH-OEM** is shipped with the following items. If any of these items is missing or damaged, please contact Sealevel for replacement.



- **HUB4PH-OEM – Sealevel Embedded High Speed 4-Port USB 2.0 Hub**
- **CA393 – +5V Internal Power Cable**



OEM models of the HUB4P do not ship with a USB cable. See the available selection of USB cable options below.

Optional Items – HUB4PH-OEM

Depending upon your application, you are likely to find one or more of the following items useful with the HUB4PH-OEM. All items can be purchased from our website (<http://www.sealevel.com>) or by calling +1 864-843-4343.

Internal USB Cable for Box Header Connectors, 14" (Item# CA469)	
<p>The CA469 is an embedded USB cable that has a 1x5 2mm Molex connector for connecting to Sealevel embedded USB products. The other end of the cable has a 1x5 0.1" (2.54mm) box header connector found on medium to large sized motherboards, including ATX, Micro ATX, Mini ATX, ITX, Mini ITX and EBX form factors. The CA469 is 14" in length and uses one USB port connection on the computer motherboard.</p>	
Internal USB Cable for 1x4 2mm Box Headers, 14" (Item# CA472)	
<p>This cable is perfect for adding Sealevel I/O modules to small embedded systems. One end of the cable has a 1x5 2mm Molex connector for internal connections to Sealevel embedded USB products. The other end of the cable has a 1x5 2mm box header connector found on very small motherboards, including EPIC, 3.5" Biscuit, ETX, Nano ITX, Pico ITX and PC/104 Small Board Computers. The CA472 is 14" in length and uses one USB port connection on the computer motherboard.</p>	
<p> One of the above two cables, while not included with the product, may save time during installation in making the Upstream USB connection to the customer supplied motherboard should the customer not desire to make his own cable.</p>	

Internal USB Cable for 2mm Molex Connectors, 14" (Item# CA471)	
<p>The CA471 is an embedded USB cable that has a 1x5 2mm Molex connector on one end for connecting to the HUB4PH and a 1x4 2mm Molex connector on the other end for internal connections to Sealevel embedded USB products. The CA471 is 14" in length.</p> <p>N While not included with the product, the above cable may save time during installation if the HUB4PH is being used along with other Sealevel USB OEM products in the customer specific application.</p>	
Low Profile PCI Bracket with Locking USB Port (Item# SL-LPCI)	
<p>The SL-LPCI easily adds a SeaLATCH locking USB port to any computer with an available low profile PCI location and provides a clean, professional installation.</p>	
PCI Bracket with Locking USB Port (Item# SL-PCI)	
<p>The SL-PCI easily adds a SeaLATCH locking USB port to any computer with an available PCI location and provides a clean, professional installation.</p>	
PCI Bracket with Dual Locking USB Ports (Item# SL-PCI2)	
<p>The SL-PCI2 easily adds two SeaLATCH locking USB ports to any computer with an available PCI location and provides a clean, professional installation.</p>	

OPTIONAL ITEMS – HUB4PH-OEM, CONTINUED

Panel Mounted Adapter with Locking USB Port (Item# SL-PM)	
<p>The SL-PM easily adds a SeaLATCH locking USB port to your enclosure, faceplate, or bulkhead. This gives you the freedom to add a locking USB port wherever it is needed.</p>	 A black, rectangular panel-mounted adapter with a locking USB port. The device has a USB Type-A port on the front face. To the right of the device, there are two small metal hardware components: a screw and a nut.

Installation

Windows 98/ME/2000/XP/Vista™ Operating Systems

1. The HUB4PH is fully supported as a generic USB hub device in Windows 98/ME/2000/XP/Vista/7™ operating systems and requires no separate driver.
2. Connect the hub to power via the included wall-mount power supply (HUB4PH) or through the internal power header (HUB4PH-KT and HUB4PH-OEM)
3. Using the included USB device cable, plug the HUB4PH into an available USB port on your host system.
4. The 'Found New Hardware' screen will appear, and the hub will be automatically recognized as a generic USB hub device.
5. The hub is ready to use when you see the screen 'Your USB hub is installed and ready to use.'



Windows NT is not USB aware and thus cannot support this device.

LINUX SUPPORT

USB devices are supported in Linux kernel v2.4 or better. Refer to the help files included with your Linux distribution for specific instructions on adding generic USB hub devices.

For additional support, please call Sealevel Systems' Technical Support, (864) 843-4343. Our technical support is free and available from 8:00AM-5PM Eastern Time, Monday through Friday. For email support contact: support@sealevel.com.

Hardware Description

Sealevel High Speed 4-Port USB 2.0 Hub

The HUB4PH is a powered USB 2.0 4-port hub that is perfect for adding high-speed USB ports to industrial computing platforms. It is USB 2.0 compliant, providing a full 480M bps data rate to the host, and is backwards compatible with USB 1.1 and 1.0 devices. The hub is configured with port 1 as a USB Battery Charging Specification BC1.2 Compliant Charging Downstream Port (CDP) capable of supplying up to 1.5A of current to the downstream device. The remaining 3 ports are configured as Standard Downstream Ports (SDP) capable of supplying up to 500mA of current to the downstream device.

The HUB4PH-KT features the iPorthole™ design that is perfect for expanding industrial computing platforms using only an internal USB connection. iPorthole modules include an intelligent USB I/O board with Sealevel's innovative Porthole mounting plate for installation in a Relio or custom enclosure.

The HUB4PH-OEM is ideal for industrial computing applications that require embedded USB ports. The hub is USB 2.0 compliant and is perfect for adding up to four USB ports to your embedded application. Several cables are available that connect the OEM hub to your system board and peripheral USB devices. The HUB4PH-OEM includes a +5V power cable that sources power from a standard hard drive connector. Included also are 0.75" high hex standoffs for mounting of the assembly.



Both the HUB4PH-KT and HUB4PH-OEM versions are configured with all four ports setup as USB Battery Charging Specification BC1.2 Compliant Charging Downstream Ports (CDP) and are capable of supplying up to 1.5A of current to the downstream device.

HARDWARE DESCRIPTION, CONTINUED

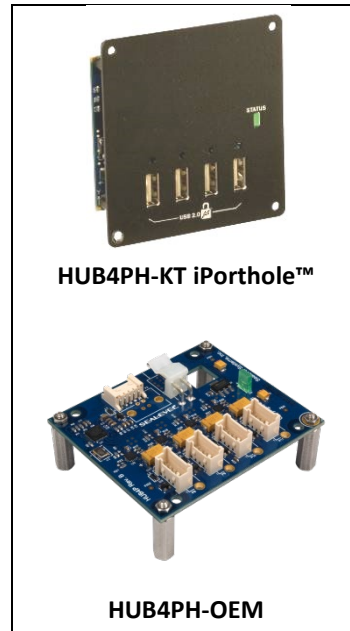

Number of Ports	4
Communications Chip	USB Hub
USB Specification	2.0 Compliant; 1.0 and 1.1 Compatible
Maximum Data Rate	480M bps
Maximum Data Distance	5 meters
Storage Temperature	-50° - +105°C
Operating Temperature	0 - +70°C
Humidity Range	10 - 90% R.H.
Power Requirement	5VDC @ 4A (HUB4PH) 5VDC @ 6.5A (HUB4PH-KT, -OEM)

HARDWARE DESCRIPTION, CONTINUED

HUB4PH

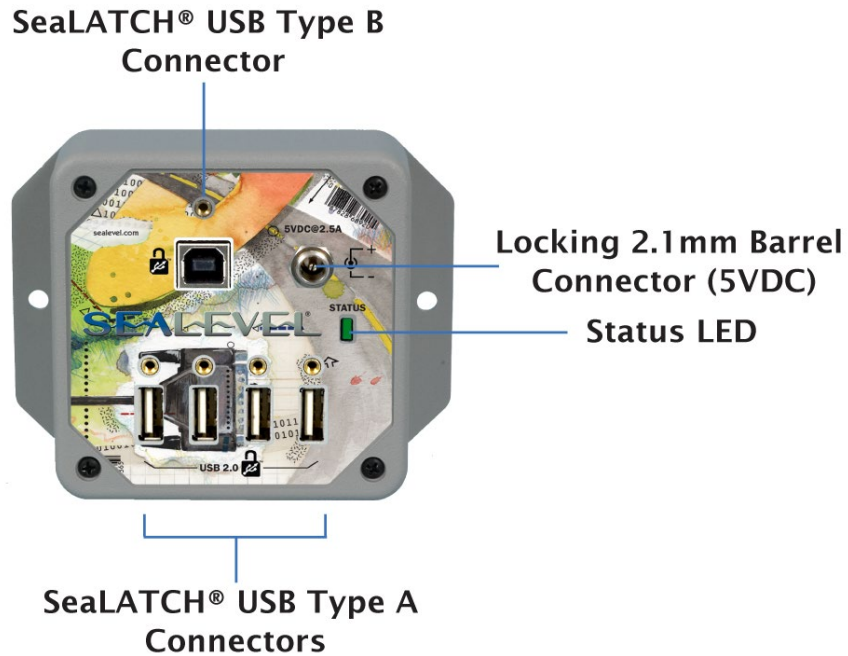

HUB4PH-KT

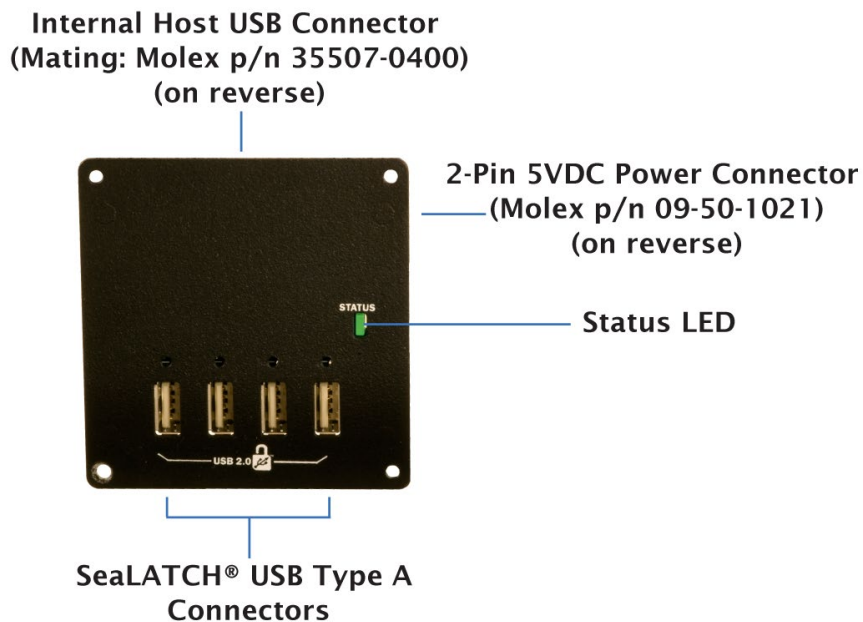

HARDWARE DESCRIPTION, CONTINUED

HUB4PH-OEM

Internal Host USB Connector
(Mating: Molex p/n 35507-0500)
(on reverse)

2-Pin 5VDC Power Connector
(Molex p/n 09-50-1021)
(on reverse)

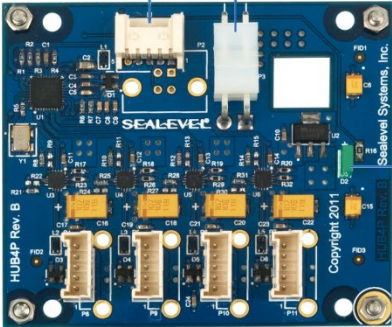

Status LED

Downstream USB Ports
(Mating: Molex p/n 35507-0500)

SeaLATCH® USB

The HUB4PH and HUB4PH-KT integrate Sealevel's SeaLATCH locking USB ports, which are fully compatible with standard USB cables. When used with SeaLATCH locking USB cables, the metal thumbscrew provides a secure metal-to-metal connection to the hub and prevents accidental cable disconnection.

Sealevel incorporates SeaLATCH locking USB ports on many USB I/O devices. Accidental cable disconnection is the most common point of failure with USB industrial I/O devices and SeaLATCH cables and connectors prevents that while being fully compatible with standard USB cables.

Examples of the HUB4PH with SeaLATCH equipped Sealevel I/O devices are shown below.

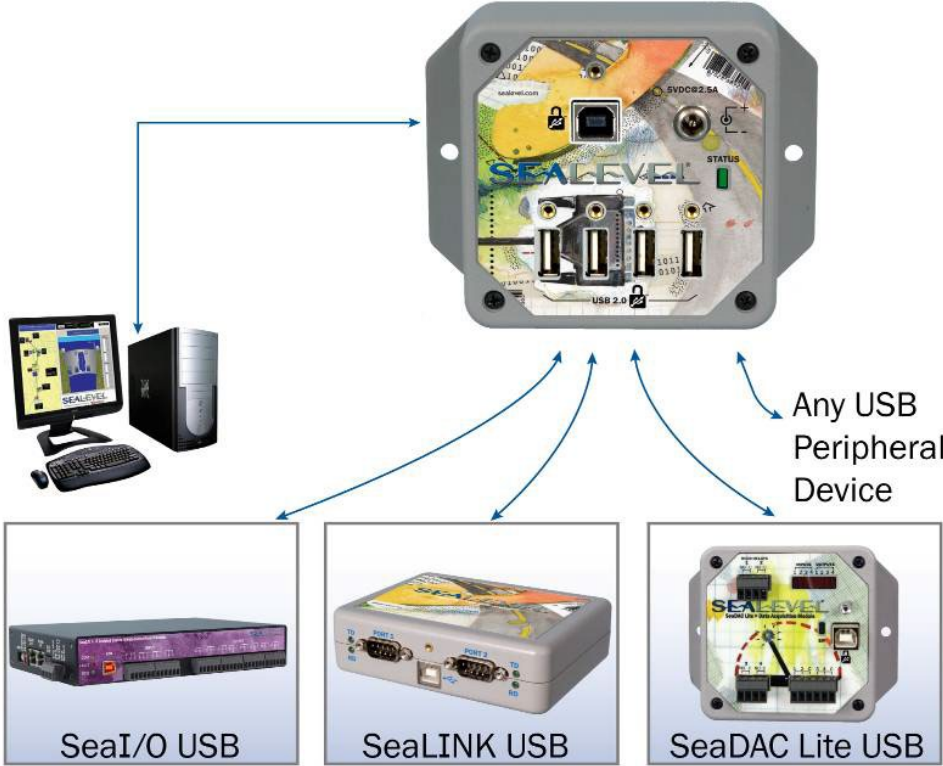

SeaLATCH® USB, CONTINUED

SeaLATCH Locking USB Cables

SeaLATCH USB Connectors

SeaLATCH locking USB cables integrate a small thumbscrew into each USB connector. SeaLATCH USB cables are fully interchangeable with standard USB cables. The thumbscrew provides a secure metal-to-metal connection preventing accidental disconnection. SeaLATCH USB cables are available in three configurations.

SeaLATCH USB Connectors

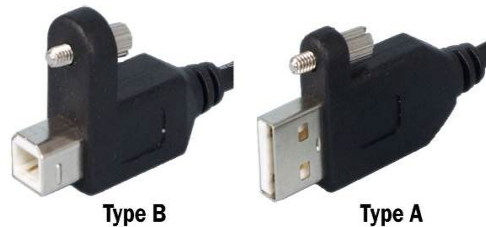

Item# CA356

The CA356 is a 72" USB cable with a SeaLATCH type B connector and a standard USB type A connector. This cable provides a secure connection between Sealevel products with a SeaLATCH type B port and legacy USB type A ports. The CA356 is included with Sealevel devices with a SeaLATCH type B port.



Item# CA332

The CA332 is a 72" cable with both SeaLATCH type A and B connectors. This cable secures both ends of the cable to devices with SeaLATCH USB ports and offers complete protection against accidental cable disconnection.



Item# CA355

The CA355 is a 72" cable with a standard USB type B and a SeaLATCH type A connector. This cable provides a secure connection between legacy USB devices and Sealevel products with a SeaLATCH type A port.



Technical Specifications

Power Requirements

Supply Line	+5 VDC
Rating	4A via locking 2.1 mm barrel connector

USB Electrical Pin-Outs

Pin Number	Signal Description
1	+5VDC
2	USB Data-
3	USB Data+
4	GND
Shell or 5	Shield

Status LED

The status LED lights to indicate that the hub is successfully communicating with the host computer.

Physical Dimensions

HUB4PH

Length	4.3 inches (10.92 cm)
Width	3.4 inches (8.63 cm)
Height	1.3 inches (3.30 cm)

TECHNICAL SPECIFICATIONS, CONTINUED

Physical Dimensions, Continued

HUB4PH-KT

Length	3.2 inches (8.13 cm)
Width	3.1 inches (7.87 cm)
Height	0.6 inches (1.52 cm)

HUB4PH-OEM

Length	2.9 inches (7.37 cm)
Width	2.5 inches (6.35 cm)
Height	0.8 inches (2.03 cm)

Environmental Specifications

Specification	Operating	Storage
Temperature Range	0°C – 70°C (32°F – 158°F)	-50°C – 105°C (-58°F – 221°F)
Humidity Range	10 to 90% R.H. Non-Condensing	10 to 90% R.H. Non-Condensing

Manufacturing

All Sealevel Systems Printed Circuit boards are built to UL 94V0 rating and are 100% electrically tested. These printed circuit boards are solder mask over bare copper or solder mask over tin nickel.

Appendix A – Troubleshooting

The HUB4PH is a generic USB hub and should provide years of trouble-free service. Should the device appear to not be functioning correctly, the following tips can eliminate most common problems without the need to call Technical Support.

1. Make sure the power supply is properly connected. The green LED on the front of the unit will light, indicating the hub is properly powered.
2. Make sure the hub is connected to a USB port using the included USB cable or a quality replacement USB cable.
3. The hub is supported in any USB aware operating system that supports generic USB hub devices, including Windows 98/ME/2000/XP/Vista/7™ operating systems and Linux (kernel v2.4 or better). No additional drivers are required. Verify that USB support is enabled in the host system BIOS and the hub is functioning properly in the operating system. You can verify the hub is working properly in Windows using Device Manager.

If these steps do not solve your problem, please call Sealevel Systems' Technical Support, (864) 843-4343. Our technical support is free and available from 8:00 AM to 5:00 PM Eastern Time Monday through Friday. For email support, contact support@sealevel.com.

Appendix B – How To Get Assistance

Please refer to: Appendix A – Troubleshooting Guide prior to calling Technical Support.

Begin by reading the Trouble Shooting Guide in [Appendix A](#). If assistance is still needed, please see below.

When calling for technical assistance, please have your user manual and current adapter settings. If possible, please have the adapter installed in a computer ready to run diagnostics.

Sealevel Systems provides an FAQ section on its web site. Please refer to this to answer many common questions. This section can be found at <http://www.sealevel.com/faq.asp>.

Sealevel Systems maintains a web page on the Internet. Our home page address is www.sealevel.com. The latest software updates, and newest manuals are available via our web site.

Technical support is available Monday to Friday from 8:00 a.m. to 5:00 p.m. eastern time. Technical support can be reached at (864) 843-4343.

RETURN AUTHORIZATION MUST BE OBTAINED FROM SEALEVEL SYSTEMS BEFORE RETURNED MERCHANDISE WILL BE ACCEPTED. AUTHORIZATION CAN BE OBTAINED BY CALLING SEALEVEL SYSTEMS AND REQUESTING A RETURN MERCHANDISE AUTHORIZATION (RMA) NUMBER.

Appendix C – Silk Screen – HUB4PH PCB

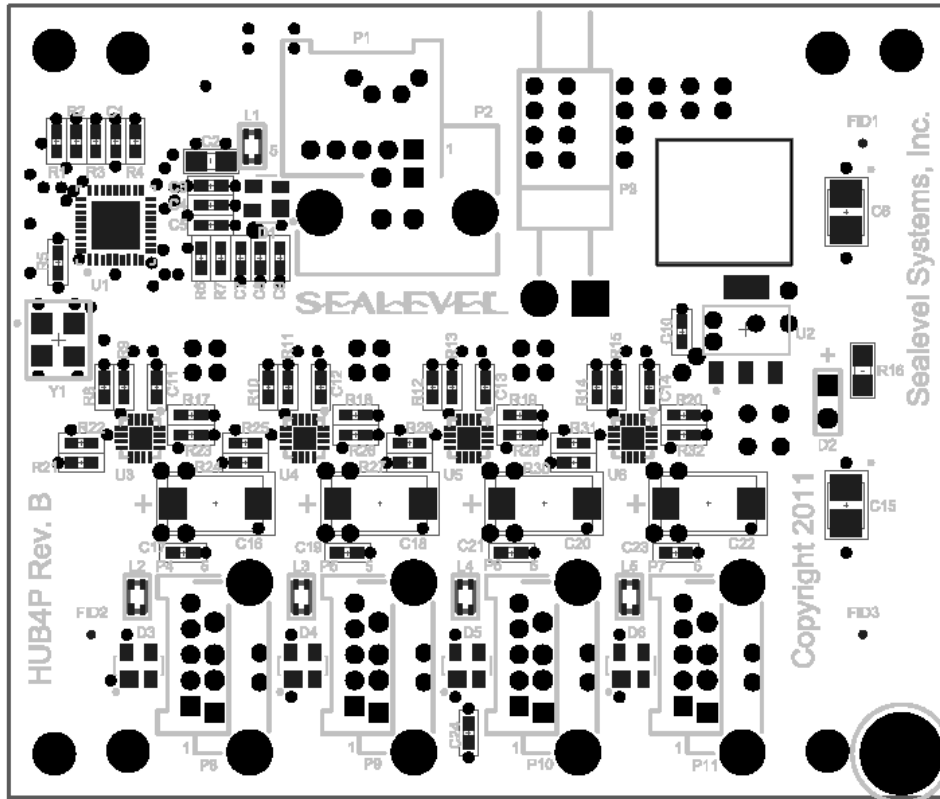

Appendix D– Compliance Notices

Federal Communications Commission (FCC) Statement



This equipment has been tested and found to comply with the limits for Class A digital device, pursuant to Part 15 of the FCC Rules. These limits are designed to provide reasonable protection against harmful interference when the equipment is operated in a commercial environment. This equipment generates, uses, and can radiate radio frequency energy and, if not installed and used in accordance with the instruction manual, may cause harmful interference to radio communications. Operation of this equipment in a residential area is likely to cause harmful interference in such case the user will be required to correct the interference at the user's expense.

EMC Directive Statement



Products bearing the CE Label fulfill the requirements of the EMC directive (89/336/EEC) and of the low-voltage directive (73/23/EEC) issued by the European Commission. To obey these directives, the following European standards must be met:

- **EN55022 Class A** - "Limits and methods of measurement of radio interference characteristics of information technology equipment"
- **EN55024** - "Information technology equipment Immunity characteristics Limits and methods of measurement".

United Kingdom Conformity Assessed Statement



Products with UKCA marking are in conformity with the essential requirements of the UK Electromagnetic Compatibility Regulations 2016:

- *Equipment must be designed and manufactured to ensure that the electromagnetic disturbance generated does not exceed the level above which radio and telecommunications equipment cannot operate as intended.*
- *The equipment has a level of immunity to the electromagnetic disturbance to be expected in its intended use which allows it to operate without unacceptable degradation of its intended use.*



This is a Class A Product. In a domestic environment, this product may cause radio interference in which case the user may be required to take adequate measures to prevent or correct the interference.



Always use cabling provided with this product if possible. If no cable is provided or if an alternate cable is required, use high quality shielded cabling to maintain compliance with FCC/EMC directives.

Warranty

Sealevel's commitment to providing the best I/O solutions is reflected in the Lifetime Warranty that is standard on all Sealevel manufactured I/O products. Relio™ industrial computers are warranted for a period of two years and the R9 family is warranted for a five-year period from date of purchase. We are able to offer this warranty due to our control of manufacturing quality and the historically high reliability of our products in the field. Sealevel products are designed and manufactured at its Liberty, South Carolina facility, allowing direct control over product development, production, burn-in and testing. Sealevel achieved ISO-9001:2015 certification in 2018.

Warranty Policy

Sealevel Systems, Inc. (hereafter "Sealevel") warrants that the Product shall conform to and perform in accordance with published technical specifications and shall be free of defects in materials and workmanship for the warranty period. In the event of failure, Sealevel will repair or replace the product at Sealevel's sole discretion. Failures resulting from misapplication or misuse of the Product, failure to adhere to any specifications or instructions, or failure resulting from neglect, abuse, accidents, or acts of nature are not covered under this warranty.

Warranty service may be obtained by delivering the Product to Sealevel and providing proof of purchase. Customer agrees to ensure the Product or assume the risk of loss or damage in transit, to prepay shipping charges to Sealevel, and to use the original shipping container or equivalent. Warranty is valid only for original purchaser and is not transferable.

This warranty applies to Sealevel manufactured Product. Product purchased through Sealevel but manufactured by a third party will retain the original manufacturer's warranty.

Non-Warranty Repair/Retest

Products returned due to damage or misuse and Products retested with no problem found are subject to repair/retest charges. A purchase order or credit card number and authorization must be provided in order to obtain an RMA (Return Merchandise Authorization) number prior to returning Product.

How to obtain an RMA (Return Merchandise Authorization)

If you need to return a product for warranty or non-warranty repair, you must first obtain an RMA number. Please contact Sealevel Systems, Inc. Technical Support for assistance:

Available	Monday – Friday, 8:00AM to 5:00PM EST
Phone	864-843-4343
Email	support@sealevel.com

Trademarks

Sealevel Systems, Incorporated acknowledges that all trademarks referenced in this manual are the service mark, trademark, or registered trademark of the respective company.