

SeaPAC R9-8.4 ARM9 Touchscreen Computer

User Manual | S91100-8R and S91200-8R



SEALEVEL[®]

Contents

- CONTENTS..... 2
- INTRODUCTION 3
- BEFORE YOU GET STARTED 4
- PRODUCT OVERVIEW..... 7
- PRODUCT VIEWS 8
- BLOCK DIAGRAM..... 9
- TECHNICAL DESCRIPTION 10
- SOFTWARE INSTALLATION 23
- SPECIFICATIONS 55
- APPENDIX A – RESOURCES..... 57
- APPENDIX B – APPLICATION DEBUGGING OVER ETHERNET 58
- APPENDIX C – CAD DRAWING 60
- APPENDIX D – HOW TO GET ASSISTANCE..... 62
- WARRANTY 63

Introduction

Overview

The SeaPAC R9-8.4 is an application-ready platform for your next product design. The system is based on the 200MHz Atmel AT91SAM9263 microcontroller boasting a 32-bit ARM® instruction set for maximum performance. With up to 256MB RAM and 256MB NAND Flash memory, the unmatched I/O features of the SeaPAC R9-8.4 extend the possible uses beyond traditional ARM applications.

To provide the fastest time to market, the Windows CE 6.0 BSP binary and low-level drivers for system I/O are included. Additionally, the SeaPAC R9-8.4 software package is equipped with the Sealevel Talos I/O Framework, which offers a high-level object-oriented .NET Compact Framework (CF) device interface. This interface provides an I/O point abstraction layer with built-in support for the specific needs of analog and digital I/O such as gain control and debouncing.

The SeaPAC R9-8.4 is housed in a rugged, small enclosure suitable for mounting almost anywhere and is rated for a -30°C to +50°C operating temperature range. The SeaPAC R9-8.4 is powered from your 7-30VDC source or select from a variety of Sealevel power supply options.

Features

- 8.4" 400 nit TFT LCD with LED backlight
- Durable resistive touchscreen
- Atmel AT91SAM9263 ARM® Processor
- Up to 256MB SDRAM and 256MB NAND Flash Memory
- (1) 10/100 BaseT Ethernet
- (2) USB 2.0 Ports
- (1) USB Device Port
- (1) CAN Bus Interface
- (2) Isolated RS-485 serial ports
- (1) Dedicated RS-485 serial port (expansion)
- (1) RS-232 serial port
- (8) Open-collector digital outputs
- 7-30VDC input power via removable terminal block
- Power 15W Max (9W nominal)
- Compatible with Windows Embedded CE 6.0 and Linux



Before You Get Started

What's Included

The SeaPAC R9-8.4 is shipped with the following items. If any of these items are missing or damaged, please contact Sealevel for replacement.

- SeaPAC R9-8.4 ARM9 Touchscreen Computer
- NAND Flash pre-programmed with CE runtime image
- Microsoft® Windows® CE 6.0 Core license

Advisory Conventions



Warning

The highest level of importance used to stress a condition where damage could result to the product, or the user could suffer serious injury.



Important

The middle level of importance used to highlight information that might not seem obvious or a situation that could cause the product to fail.



Note

The lowest level of importance used to provide background information, additional tips, or other non-critical facts that will not affect the use of the product.

Quickstart Kit

The SeaPAC R9-8.4-KT QuickStart kit is available, which includes the most common accessories. For applications with specialized hardware requirements, developers can use the SeaPAC R9-8.4 as a platform for application development while Sealevel designs a customized target system specific to the user's application requirements.



The SeaPAC R9-8.4-KT includes the following items:

- SeaPAC R9-8.4 - ARM9 Touchscreen Computer
- NAND Flash pre-programmed with CE runtime image
- Microsoft Windows CE 6.0 Core License
- CA356 - USB Type A to SeaLATCH USB Type B, Device Cable
- CA452 - SeaPAC R9 Serial Debug Cable, DB9F to DB9F, straight through, 6ft length
- CA246 - CAT5 patch cable, 6ft length

Optional Items

Depending upon your application, you are likely to find one or more of the following items useful with the SeaPAC R9-8.4. All items can be purchased from our website (www.sealevel.com) by calling our sales team at (864) 843-4343.

Cables

USB Type A to USB Type B, 72" in Length - Device Cable (Item# CA179)	
The CA179 is a 72" standard USB device cable that connects USB peripherals with a Type B connector to the Type A connector on a host computer. The CA179 is USB 2.0 compliant and is compatible with USB 1.1 and 1.0 devices.	
CAT5 Patch Cable, 7' in Length – Blue (Item# CA246)	
Standard 7' CAT5 UTP Patch Cable (RJ45).	
SeaPAC R9 Serial Debug Cable, 6ft Length (Item# CA452)	
The CA452 is a 6ft serial debug cable with standard DB9F connector on both ends, wired straight through. The DB9F connector is compatible with any standard RS-232 DB9M serial port.	

Power Supply

100-240VAC to 12VDC @ 4.0A LPS, Desktop Power Supply (Item# TR135)	
The TR135 is a desktop (brick style) power supply rated for 100-240VAC input and 12VDC output at 4.0 amps LPS. The cable has tinned leads for use with products that have screw terminals for input power.	

Product Overview

Specifications

Processor

Atmel (AT91SAM9263) – 200MIPS RISC Processor
16KB Data Cache, 16KB Instruction Cache, Write Buffer
Integrated Memory Management Unit (MMU)

Memory

128MB (Item #S91100-8R) or 256MB (Item #S91100-8R) SDRAM
256MB NAND Flash

Display

8.4" 400 nit TFT LCD with LED backlight
640 x 480 Resolution
16-Bit Color

Touchscreen

5-wire Resistive Touchscreen

Bus Interfaces

10/100 BaseT Ethernet
USB Device Port
Two USB 2.0 Ports
CAN Bus
Dedicated RS-485 Expansion

Industrial I/O

Two Isolated RS-485 Ports
One RS-232 Port, with Full Modem Control
Eight Open-Collector Outputs (5 – 30V; 2 with PWM)

Product Views

SeaPAC R9-8.4 Left



SeaPAC R9-8.4 Right



SeaPAC R9-8.4 Front



Block Diagram

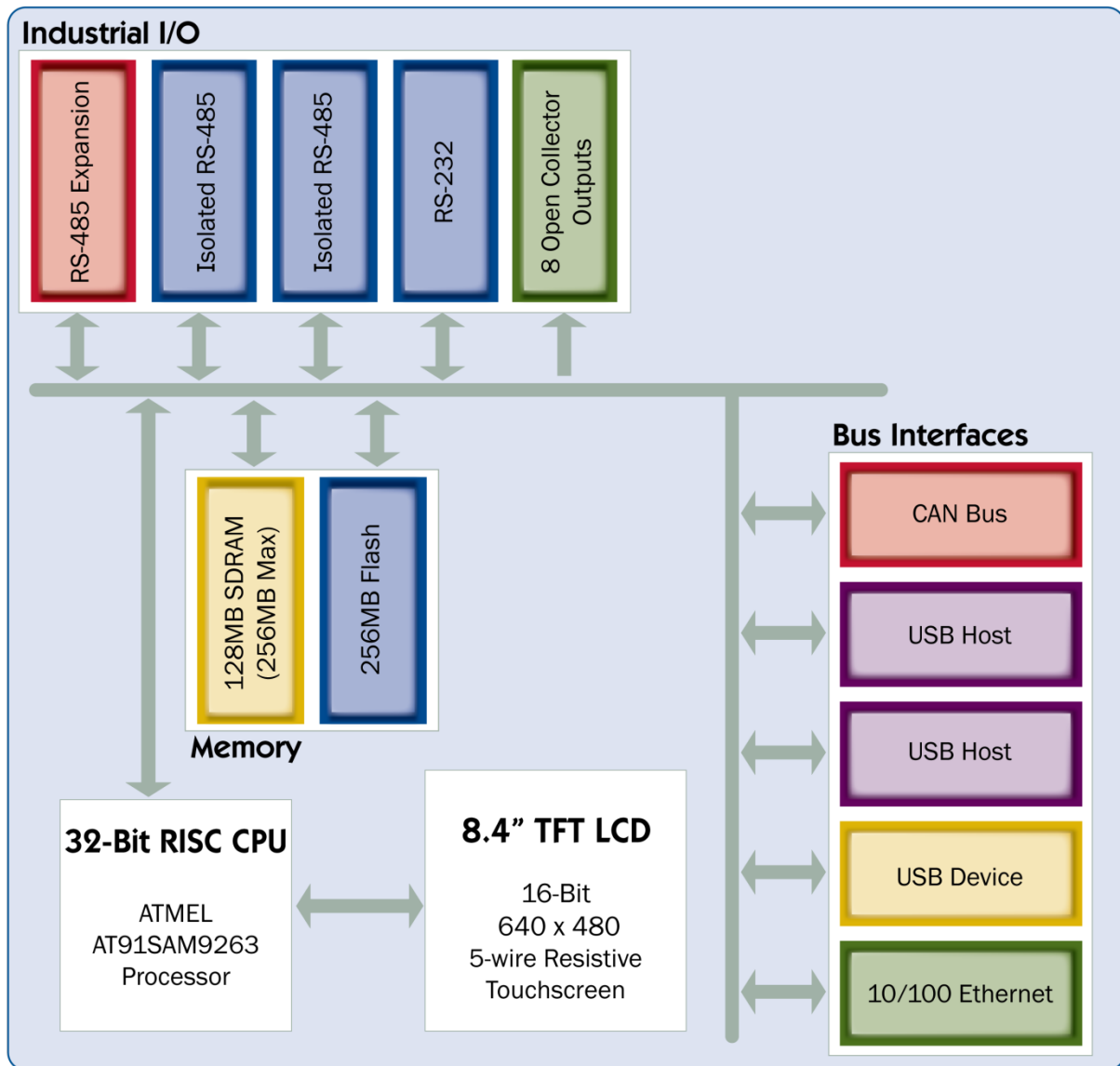

Technical Description

Memory

The SeaPAC R9-8.4 is offered with 128MB SDRAM (Item #S91100-8R) or 256 MB SDRAM (Item #S91200-8R.) Both offerings provide 256MB NAND Flash.

Ethernet

The SeaPAC R9-8.4 includes a 10/100 BaseT Ethernet interface accessed via the RJ45 connector located on the front of the enclosure.



The RJ45 port on the left side of the SeaPAC R9-8.4 is a RS-485 Expansion Port (labeled “RS-485 OUT”) and is NOT an Ethernet port. Damage to Ethernet networking equipment can result if connected to the RS-485 RJ45 connector.

Pin	Signal
1	TX+
2	TX-
3	RX+
4	NC
5	NC
6	RX-
7	NC
8	NC

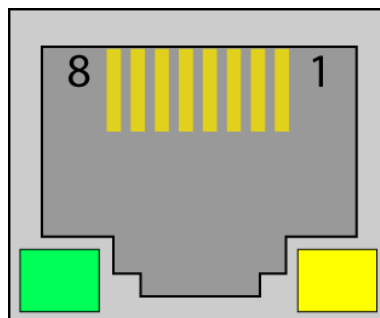

USB

The SeaPAC R9-8.4 provides two SeaLATCH USB 2.0 host ports, and one USB device port. The USB host ports are located on the left side of the enclosure. The USB device port is located on the front of the enclosure.

Connector:	SeaLATCH USB 2.0 Host Port
Manufacturer:	Samtec
Description:	Standard USB Type A
Mates with:	SeaLATCH USB Type A, or Standard USB Type A

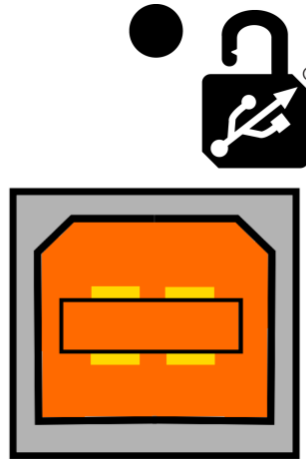

Connector:	USB 2.0 Device Port
Manufacturer:	Samtec
Description:	Standard USB Type B

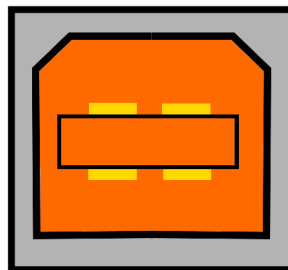

Display and touchscreen

The SeaPAC R9-8.4 features a bright 8.4" TFT LCD with LED backlight, and a durable 5-wire resistive touchscreen.

Serial Communications

Connect to a variety of serial peripherals via the SeaPAC R9-8.4's serial ports. Two isolated RS-485 serial ports are provided, via DB9 male connectors, labeled "RS-485 1" and "RS-485 2" on the lower front panel of the unit. Switch settings are provided to control the termination and pull-up/pull-down resistors.

Also provided is a RS-232 serial port with full modem control, labeled "RS-232" on the right side panel. The interface is via DB9 male connector.



Two RS-485 Serial Ports



RS-232 Serial Port

Connectors: RS-485 1 and RS-485 2
Description: DB-9 Male

PIN	RS-485 Isolated
1	NC
6	NC
2	NC
7	NC
3	DATA-
8	NC
4	DATA+
9	NC
5	GND

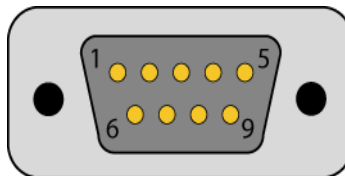

Connector: RS-232
Description: DB-9 Male

PIN	RS-232
1	DCD
6	DSR
2	RX
7	RTS
3	TX
8	CTS
4	DTR
9	RI
5	GND

COM Port Assignments

Serial Port	Assignment
RS485 Expansion Port	COM1
RS-485 1	COM2 (USART1)
RS-485 2	COM3 (USART2)
RS-232	COM4

RS-485 Termination and Pull-up/Pull-down Resistors

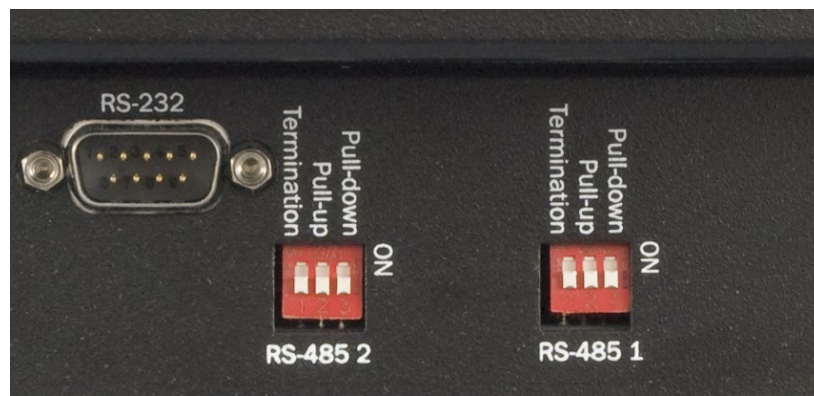

Each RS-485 Isolated port has selectable line conditioning via three DIP switches. These switches control RS-485 line termination and pull-up and pull-down resistors.

Port	DIP Switch	Position	Result
RS-485 1	Termination	OFF (Down or away from screen) ON (Up or toward screen)	DISABLED - No termination ENABLED - Terminate between D+ and D- lines with 120 ohm resistor
RS-485 1	Pull-up	OFF (Down or away from screen) ON (Up or toward screen)	DISABLED - No pull-up ENABLED- Pull-up D+ line to isolated 3.3V ISO1 plane via 510 ohm resistor
RS-485 1	Pull-down	OFF (Down or away from screen) ON (Up or toward screen)	DISABLED - No pull-down ENABLED - Pull-down D- line to isolated GND ISO1 plane via 510 ohm resistor
RS-485 2	Termination	OFF (Down or away from screen) ON (Up or toward screen)	DISABLED - No termination ENABLED - Terminate between D+ and D- lines with 120 ohm resistor
RS-485 2	Pull-up	OFF (Down or away from screen) ON (Up or toward screen)	DISABLED - No pull-up ENABLED - Pull-up D+ line to isolated 3.3V ISO2 plane via 510 ohm resistor
RS-485 2	Pull-down	OFF (Down or away from screen) ON (Up or toward screen)	DISABLED - No pull-down ENABLED - Pull-down D- line to isolated GND ISO2 plane via 510 ohm resistor

The pull-up and pull-down resistors ensure that the input ports are at a known state when not driven by the RS-485 line. The first and last devices in a RS-485 chain should enable line termination, as well as the pull-up and pull-down resistors.

CAN Bus

Connect directly to a Control Area Network (CAN) bus via the CAN connector on the left side of the enclosure.

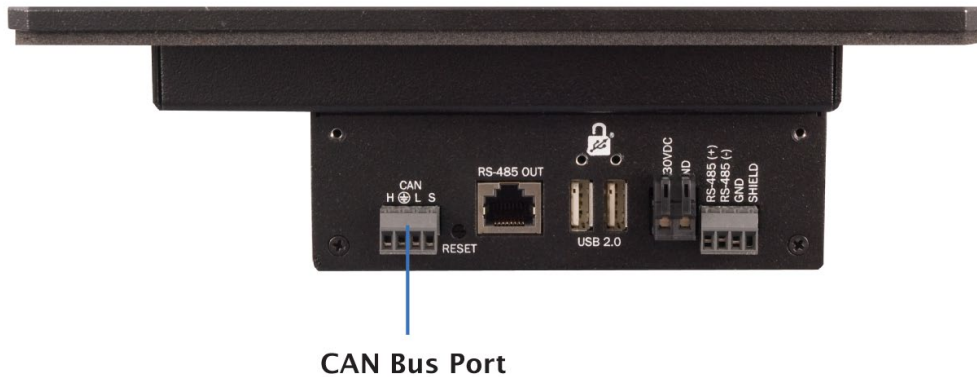

Connector: CAN
Manufacturer: Weco
Part Number: 110-M-111/04
Description: Terminal Block 4 position 3.5mm spacing
Mates with: Weco 110-A-111/04 4 position screw-terminal plug (provided)

Pin	Signal
H	CAN High
	GND
L	CAN Low
S	Shield

Open Collector Outputs

Directly control eight outputs via the SeaPAC R9-8.4's open-collector outputs found on the front of the enclosure. The open collector outputs have a range of 5 – 30V with a maximum sink current of 500mA on a single output with a combined maximum sink current of 580mA on all outputs.

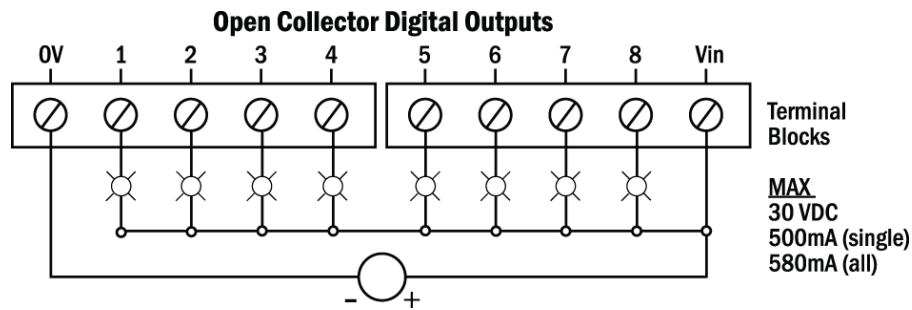

Connector:	OPEN-COLLECTOR OUTPUTS
Manufacturer:	Weco
Part Number:	110-M-111/10
Description:	Terminal Block 10 position 3.5mm spacing
Mates with:	Weco 110-A-111/10 10 position screw-terminal plug (provided)

Pin	Signal
0V	GND
1	Output 1
2	Output 2
3	Output 3
4	Output 4
5	Output 5
6	Output 6
7	Output 7
8	Output 8
Vin	OCVCC

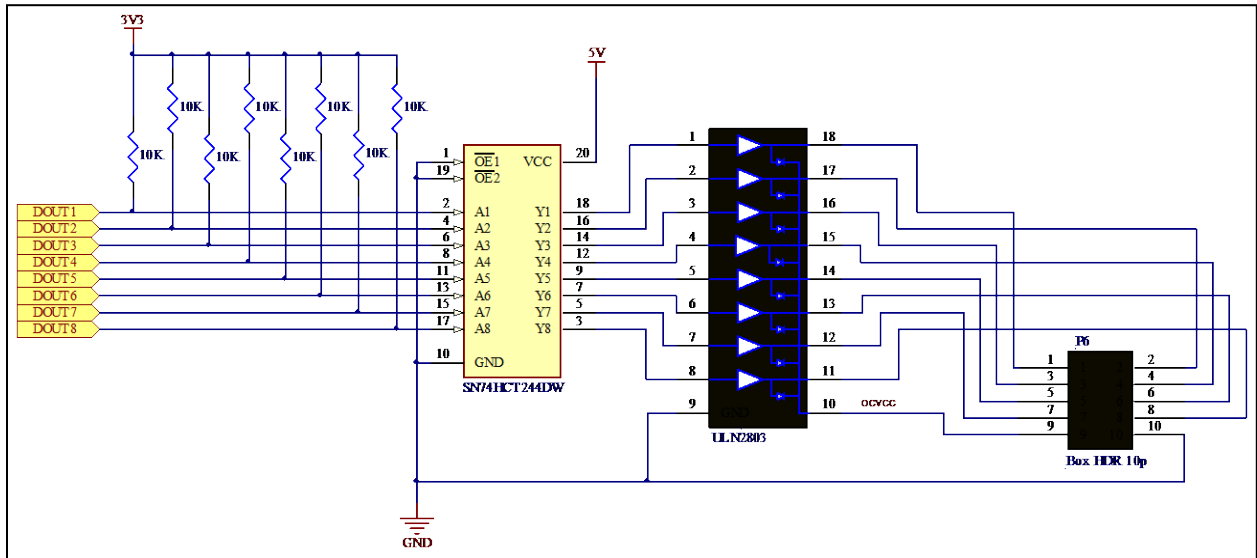

Open Collector Digital Outputs

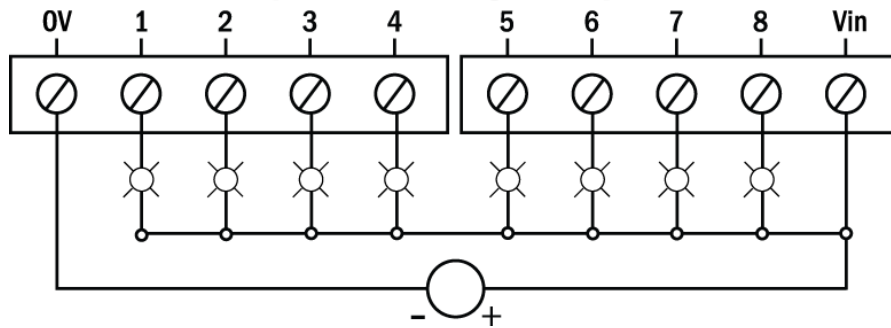

Terminal
Blocks

MAX
30 VDC
500mA (single)
580mA (all)

RS-485 Expansion

The SeaPAC R9-8.4 provides a RS-485 Expansion Port. The port is available on the left side of the enclosure via the RJ-45 connector labeled “RS-485 OUT,” as well as via a 4 pin terminal block.

The SeaPAC R9-8.4 includes a RS-485 expansion connector on the left side of the unit that is internally connected to the same pins on the screw terminals, also on the left side of the unit. This offers two convenient options for adding additional expansion modules from the Seal/O product line.



The RJ45 port on the left side of the SeaPAC R9-8.4 is a RS-485 Expansion Port (labeled “RS-485 OUT”) and is NOT an Ethernet port. Damage to Ethernet networking equipment can result if connected to the RS-485 RJ45 connector.



RS-485 Expansion Port (RJ45)

Connector: RS-485 Expansion (RJ45)
Manufacturer: Xmultiple
Part Number: XRJM-S-01-8-8-F2 or XRJM-S-01-8-8-0
Description: RJ45 Socket, W/O LEDs, Shielded
Mates with: Standard RJ45 Plug

Pin	Signal
1	9-30VDC Source
2	9-30VDC Source
3	Not connected
4	485+
5	485-
6	Common (GND)
7	Common (GND)
8	Common (GND)

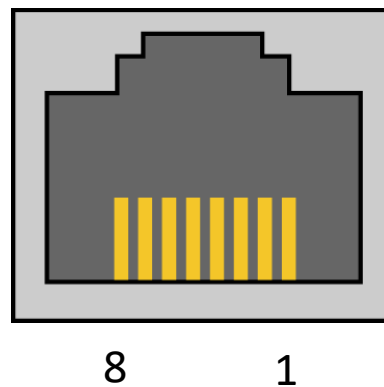

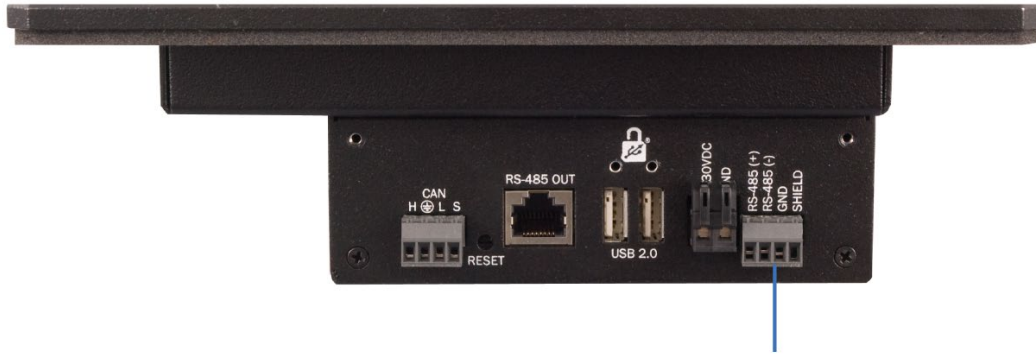

**RS-485 Expansion Port
(terminals)**

Connector: RS-485 Expansion
Manufacturer: Weco
Part Number: 110-M-111/04
Description: Terminal Block 4 position 3.5mm spacing
Mates with: Weco 110-A-111/04 4 position screw-terminal plug (provided)

Pin	Signal
RS-485 (+)	485+
RS-485 (-)	485-
GND	Common (GND)
SHIELD	Shield (GND)

Debug port

A serial debug port is provided via DB9 male connector, labeled “DBGU.” A SeaPAC R9 Serial Debug cable (Item# CA452) may be used to access the DBGU port from a Host PC. Connect one DB9 female end of the SeaPAC R9 serial debug cable to the DBGU port, and the other to the Host PC (an available RS-232 COM port or USB to RS-232 serial port adapter is required on the Host PC.)



Connector: DBGU
Description: DB-9 Male

PIN	DBGU (RS-232 levels)
1	NC
6	NC
2	TX
7	NC
3	RX
8	NC
4	NC
9	NC
5	GND

Reset button

A recessed reset button is provided to reset the SeaPAC R9-8.4. A blunt non-conductive instrument may be used to press the button and assert a reset to the processor and peripherals.

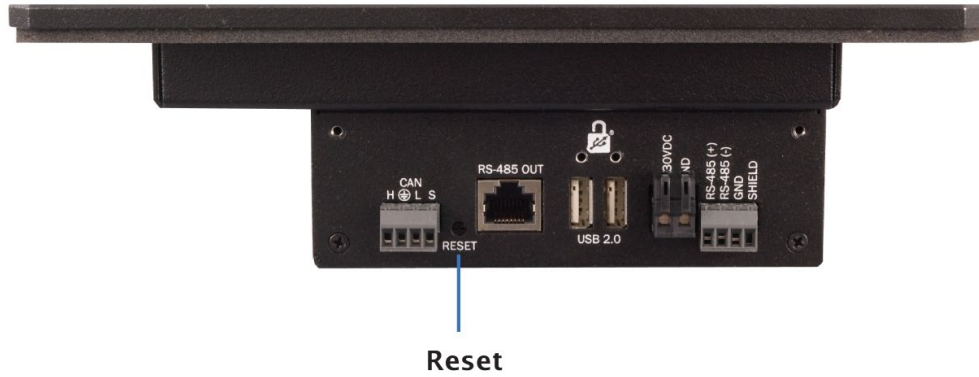

Software Installation



Only users running Windows 7 or newer should utilize these instructions for accessing and installing the appropriate driver via Sealevel’s website. If you are utilizing an operating system prior to Windows 7, please contact Sealevel by calling 864.843.4343 or emailing support@sealevel.com to receive access to the proper driver download and installation instructions.

SeaPAC R9-8.4 Quick Start

Begin by download R9 Development for Windows. Click the download “R9 Development (Windows SDK)” button. This will install Talos Framework, binaries, documentation, and examples on your PC (See Figure 1.)

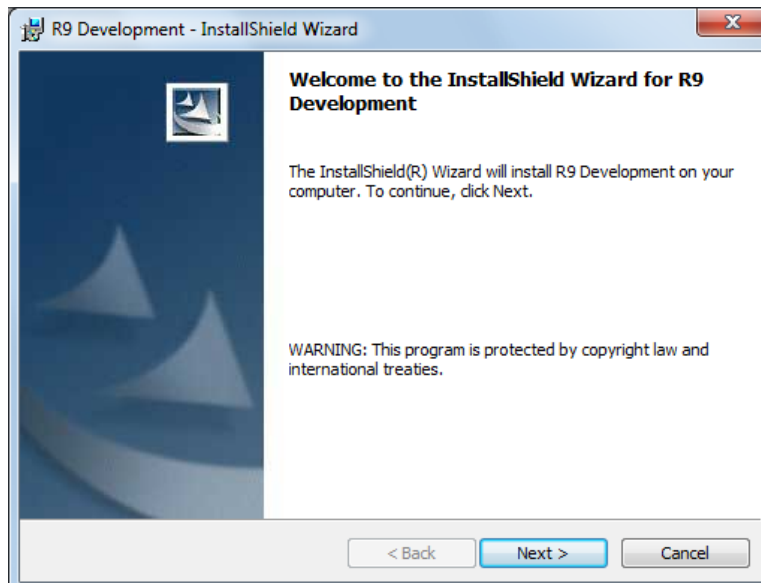

Figure 1 - Installation Wizard

After installation, the package can be found in Windows by clicking Start → All Programs → Sealevel Systems → R9 Development.

The contents of the factory provided NAND Flash build will allow the R9-8.4 to run Windows CE 6.0 OS when power is applied to the unit.

The Talos Net Framework is also located on Sealevel’s website:

<https://www.sealevel.com/support/software-talos-net-framework-windows/>.



To avoid accidental damage, be sure to follow proper *ESD procedures* by grounding yourself and the board.

Apply power to the SeaPAC R9-8.4 by connecting the TR135 tinned leads to the SeaPAC R9-8.4 input power connector screw terminals, noting proper polarity. Attach the other end of the TR135 into a 120VAC wall outlet.

Use a standard USB device cable and connect the Type B connector to the SeaPAC R9-8.4. Connect Type A connector into the host system. (See *Figure 2*.)



Figure 2 - Type B USB Device Connector

You are now ready to set up a USB communication interface between the host PC and the SeaPAC R9-8.4. Depending on which operating system you are using – Windows 7, Vista, or XP – the setup experience will vary.

Windows Device Center

If your host PC is running Windows Vista or later and you are connected to the Internet, then Windows Mobile Device Center software will install automatically. If you are not connected to the Internet but have obtained the Windows Mobile Device Center software manually, then running their setup will achieve the same result. (See [Appendix A](#).)

After installation, a negotiation will begin between the PC and the SeaPAC R9-8.4 board and the device center connection screen will appear. (See Figure 3.)



Figure 3 - Device Center Connected

Using your mouse, select "Connect without setting up your device". The idea is to explore the file system on the SeaPAC R9-8.4 without setting up synchronization with contacts, calendar, or e-mail. Now choose "File Management → Browse the contents of your device" from the screen. (See Figure 4.)



Figure 4 - Device Center File Management

This action opens a standard Windows Explorer where the default file contents of the SeaPAC R9-8.4 can be read or written to. (See Figure 5.)

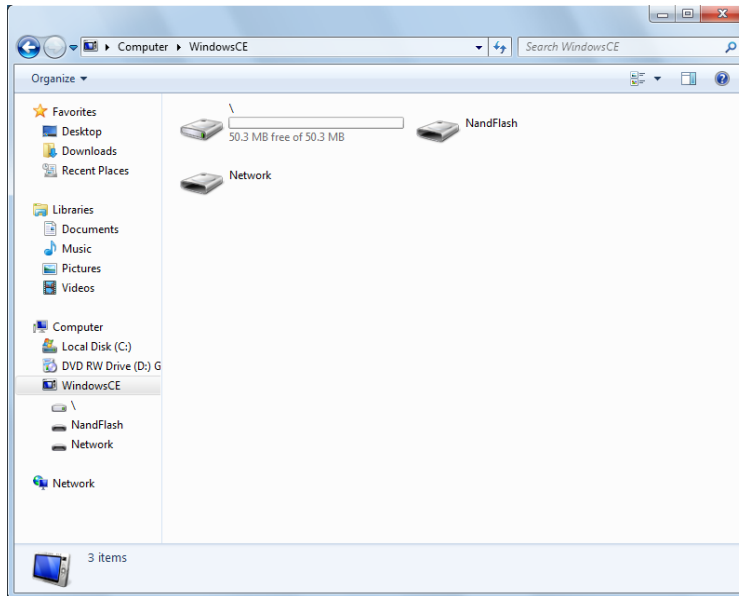

Figure 5 - Contents of SeaPAC R9-8.4 1

Windows ActiveSync for XP

If your host PC is running Windows XP, ActiveSync is required to establish connection to the SeaPAC R9-8.4. ActiveSync differs from Windows Mobile Device Center in that having an internet connection will not establish an automatic download and installation. For installation procedures, refer to Microsoft's website. (See [Appendix A](#)). After installation, a negotiation will begin between the PC and the SeaPAC R9-8.4 board, and the "New Partnership" dialog will appear. (See Figure 6.)



Figure 6 - ActiveSync New Partnership Dialog

Using your mouse, select “No” and then select “Next”. The ActiveSync main dialog will appear. Select the “Explore” icon. This action opens a standard Windows Explorer where the default file contents of the SeaPAC R9-8.4 can be read or written. (See Figure 7.)

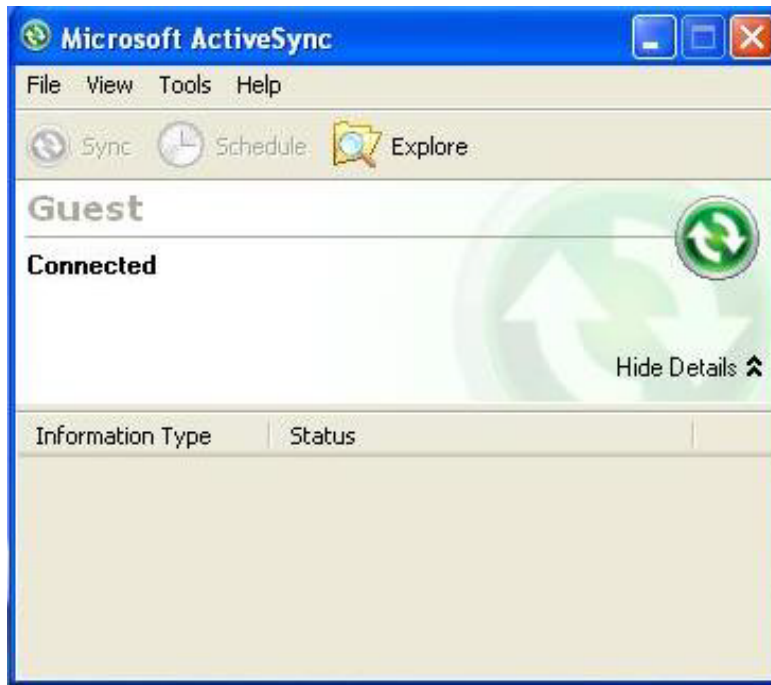

Figure 7 - ActiveSync Main Dialog

Connection Complete

You are now ready to set up a complete development environment for building and debugging smart device applications and libraries. The next section guides you by example using Microsoft Visual Studio.

Programming Using The .NET Compact Framework

Application Development

Introduction

With .NET Compact Framework coupled with our Talos .NET Framework, C# and VB.NET programmers can develop powerful embedded applications on the SeaPAC R9-8.4 such as mobile, robotics, home automation, industrial, and a broad range of other embedded applications. The low cost of licensing for Windows 6.0 CE has created an ideal environment to develop a new generation of embedded products around the SeaPAC R9-8.4.

Our Talos Framework allows access to the more specific I/O sections of the SeaPAC R9-8.4 development board such as digital output points, CAN bus, and the serial ports. A complete list of the API documentation can be found in Windows by clicking Start à All Programs à Sealevel Systems à R9 Development à Talos Documentation.html.

Writing .NET applications for the SeaPAC R9-8.4 is very similar to writing desktop or console applications for XP and Vista. The only difference is the number of resources available. Because the memory footprint is smaller compared to a desktop computer, care should be taken where allocation of memory is concerned, such as large object creation.

Requirements

- Visual Studio Professional 2005 or 2008
- .NET Compact Framework 3.5

Getting Started

For this demonstration, we will construct a smart device console application using Visual C#. Start Visual Studio and select File → New → Project. A 'New Project' dialog will appear. Select a project type of Visual C# → Smart Device. Select 'Smart Device Project' as the Template. Make sure the combo box has .NET Framework 3.5 selected. Type the name of the project. In this case, call it *HelloWorld*. (See Figure 8.)

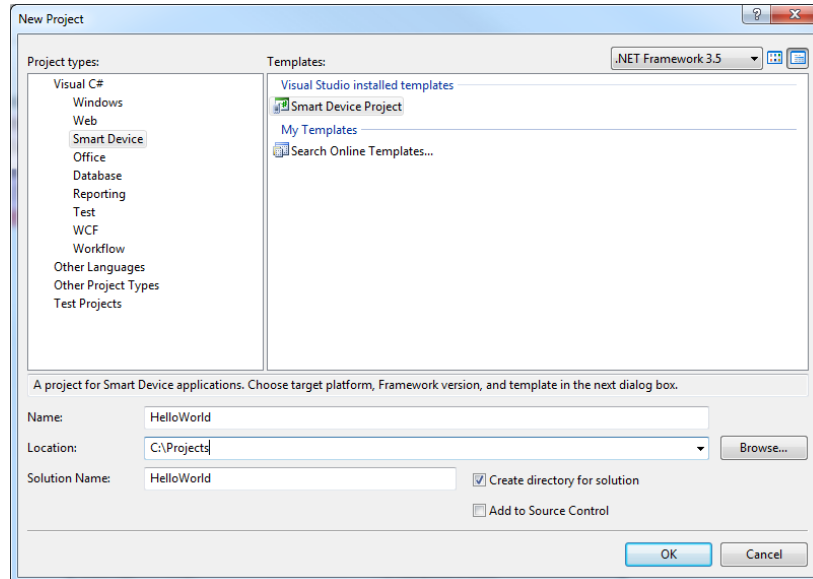

Figure 8. Visual Studio New Project Dialog

Click the "OK" button. The next configuration screen allows you to select the type of project you are creating. Select "Windows CE" for the target platform, .NET Compact Framework version 3.5 and select the "Console Application" icon for the template. (See Figure 9.)

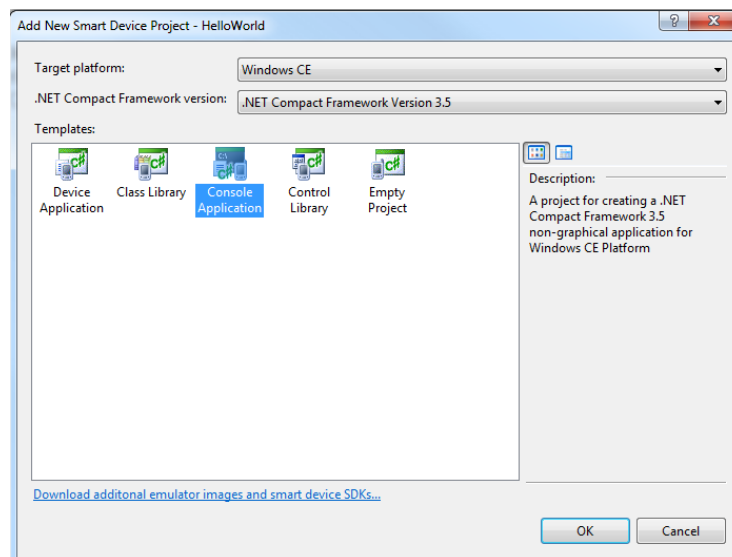

Figure 9. Visual Studio Add Smart Device Dialog

Once you have selected all of the configuration options, click the "OK" button. You will now see a console application template called *HelloWorld* in Visual Studio. (See Figure 10.)

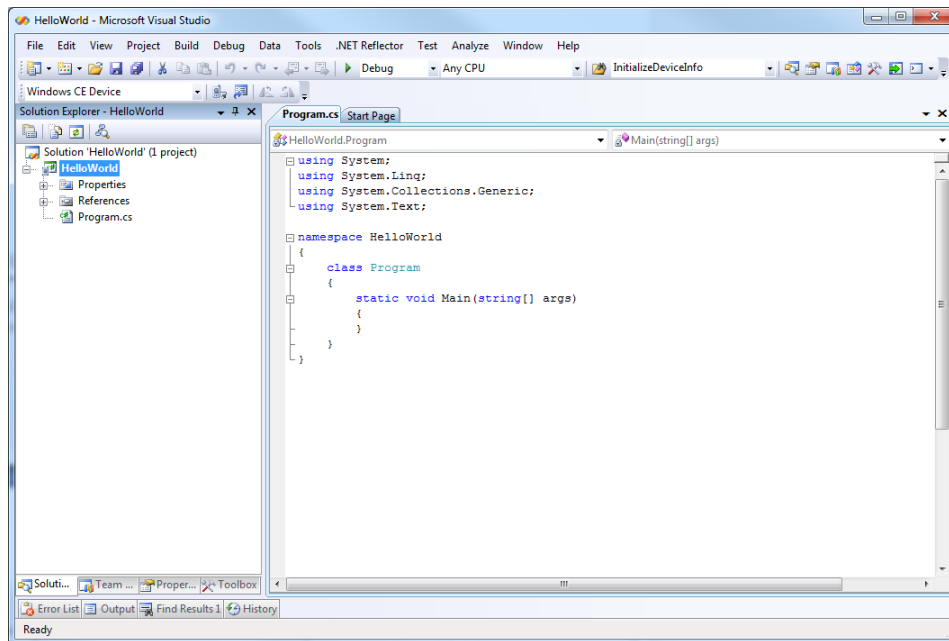

Figure 10. Visual Studio Main Window

We can now add the references to the Talos Framework. Right click on the "References" and select the "Add Reference..." selection. (See Figure 11.)

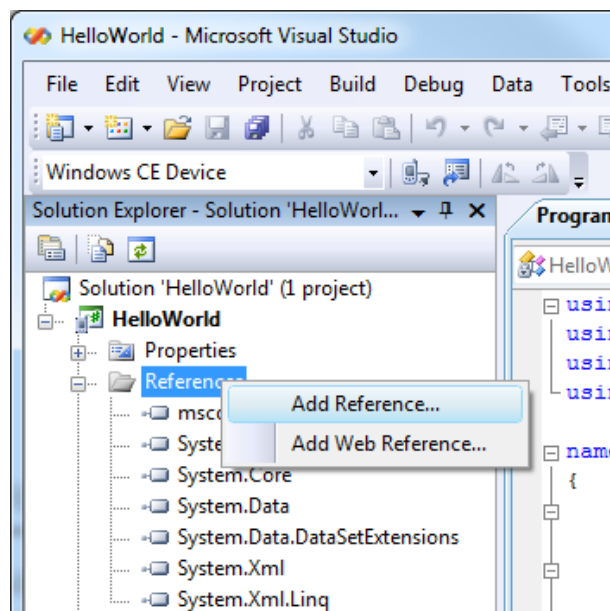

Figure 11. Adding References to Project

An 'Add Reference' dialog will appear. Click on the 'Browse' tab then search for the installed library path "C:\Program Files\Sealevel Systems\R9 Development\Assemblies". If you don't see a list of the R9 libraries as shown in Figure 12, then refer to the SeaPAC R9-8.4 QuickStart section for software installation details. While holding down the CTRL key, click on both "SLCorLib.dll" and "Talos.dll". Click the "OK" button. (See Figure 12.)

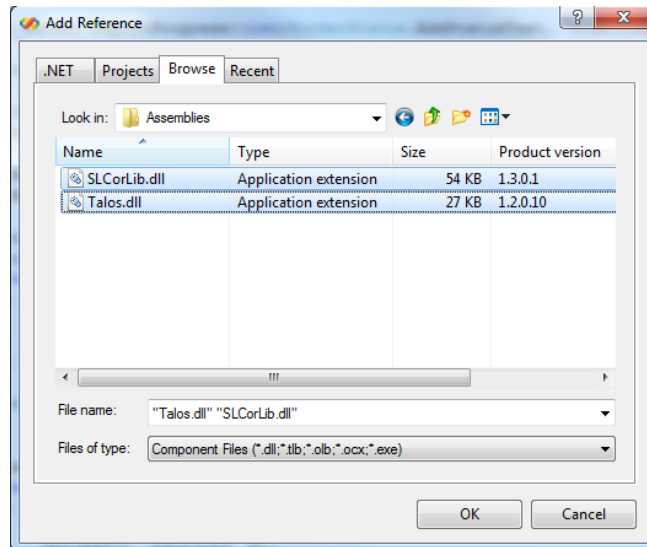

Figure 12. Core Library References

Both DLLs should appear in your "References" list. (See Figure 13.)

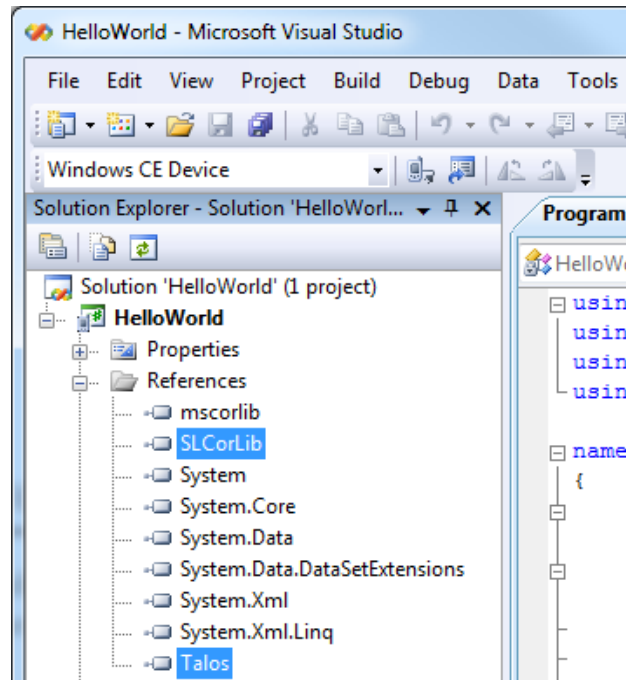

Figure 13. Verification of Added Library References

Now that the Talos Framework has been referenced, you have access to all the I/O points exposed on the SeaPAC R9-8.4 device.

For this simple HelloWorld application, we will just echo the string “Hello World” in the console window. This can be accomplished by adding the following code to the automatically created Program::Main() method. This code will echo “Hello World” and then pause for 5 seconds.

```
static void Main(string[] args)
{
    Console.WriteLine("Hello World");
    System.Threading.Thread.Sleep(5000);
}
```

From Visual Studio’s menu bar, select “Build → Build HelloWorld”. After the build process has completed select from the same menu bar, “Build → Deploy HelloWorld”. A “Deploy HelloWorld” dialog will appear for you to choose the appropriate target. Choose “Windows CE Device” then press the ‘Deploy’ button. (See Figure 14.)

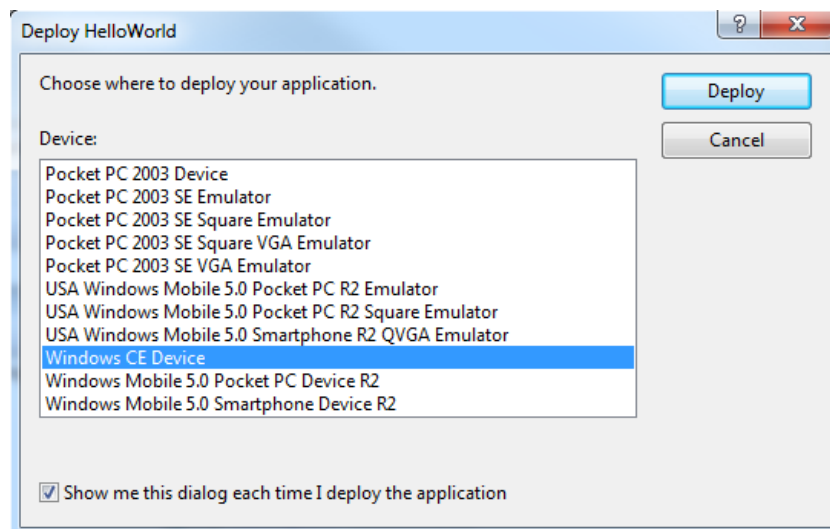

Figure 14. Choose Windows CE Device and Deploy

After the deployment phase, select “Debug->Start Without Debugging” from the Visual Studio menu bar. A console will appear to display the “Hello World” message. After 5 seconds, the window will automatically close.

Examples can be found from the installation directory under ‘..\R9 Development\Samples\C#’ and ‘..\R9 Development\Samples\VB.NET’.

Application Debugging

Introduction

This guide details the process of debugging an application developed for the SeaPAC R9-8.4 embedded IO system. The SeaPAC R9-8.4 development platform easily integrates into standard Microsoft development tools to make the debugging process extremely easy. The following sections detail the requirements to begin debugging an application on Microsoft Windows 7, Vista, or XP.

Requirements

- Microsoft Windows Mobile Device Center using Vista or ActiveSync using XP
- Microsoft Visual Studio Professional 2005 or 2008
- USB Cable or Ethernet connection

Debugging your SeaPAC R9-8.4 applications is a simple process that requires a USB cable or Ethernet connection, Microsoft device synchronization software, and Visual Studio. Depending on your version of Windows, you will need to follow a different process to install the device synchronization software as outlined in the SeaPAC R9-8.4 Quick Start section.

Debugging an Application

Once the SeaPAC R9-8.4 has been successfully attached to your PC, it is easy to begin debugging an application on the SeaPAC R9-8.4. This section will demonstrate how to attach the Microsoft Visual Studio debugger to the SeaPAC R9-8.4, show the use of breakpoints in the debugger, and show how to access useful information while debugging an application.

We will be using the GPIO example application found in the "samples" directory of the Talos Framework installation. The same methods will apply to any application you wish to debug on the SeaPAC R9-8.4.

Attach the Debugger

Once your solution is opened, it is necessary to specify the device target that you would like to use in conjunction with the debugger. The default option is an emulator. Select "Windows CE Device" from the target device drop down. (See Figure 15.)

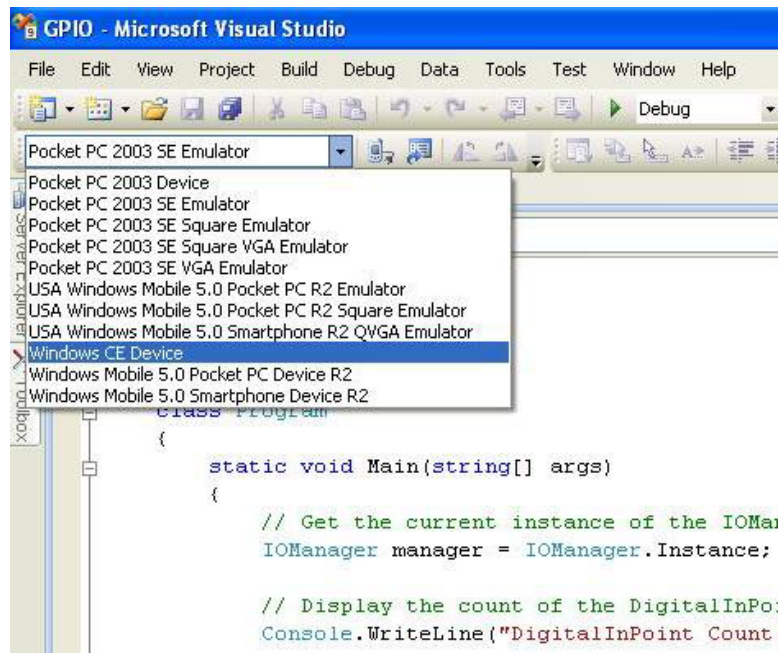

Figure 15. Device Target Selection

If you would like to use the faster Ethernet connection for debugging instead of the USB connection, refer to [Appendix B](#).

Now select the “Connect to Device” icon to initiate synchronization between Visual Studio and the SeaPAC R9-8.4 device. (See Figure 16.)

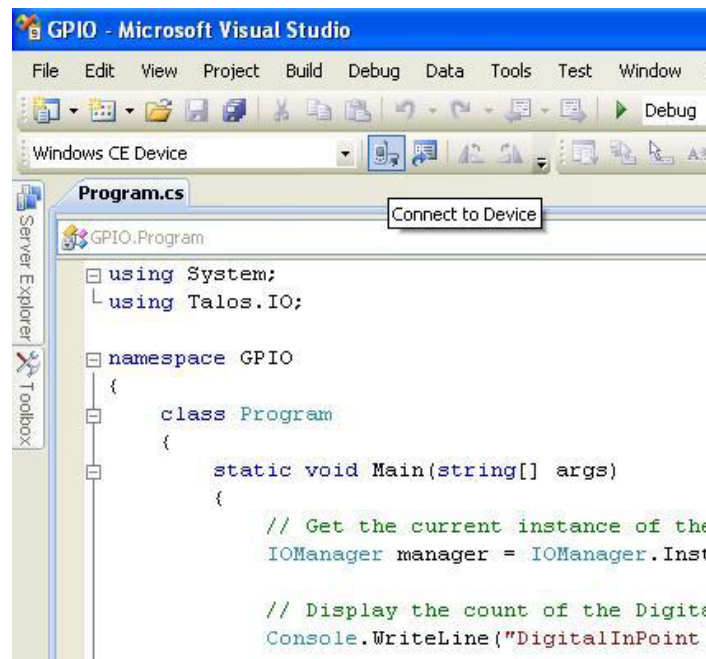

Figure 16. Connect to Device Icon

You should now see a connection dialog appear. (See Figure 17.)



Figure 17. Connection Status Dialog

Breakpoints

Setting breakpoints allows you to stop execution of your application at any point and examine the state of the application. A breakpoint may be set by selecting a line and pressing the "F9" hotkey. (See Figure 18.)

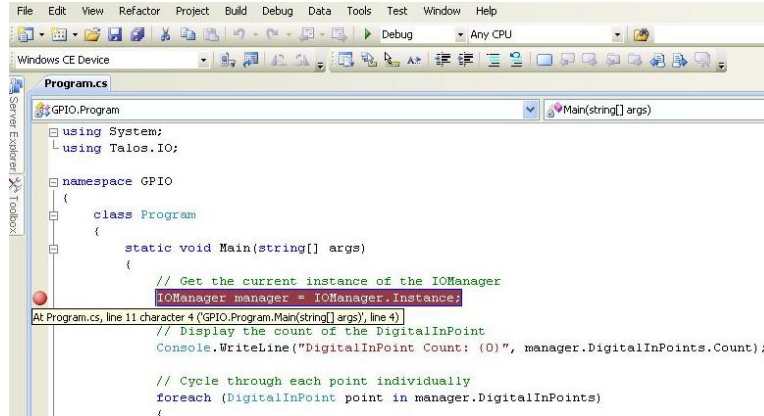

Figure 18. Breakpoint Selection

To begin debugging the application, click the "Start Debugging" button. (See Figure 19.)

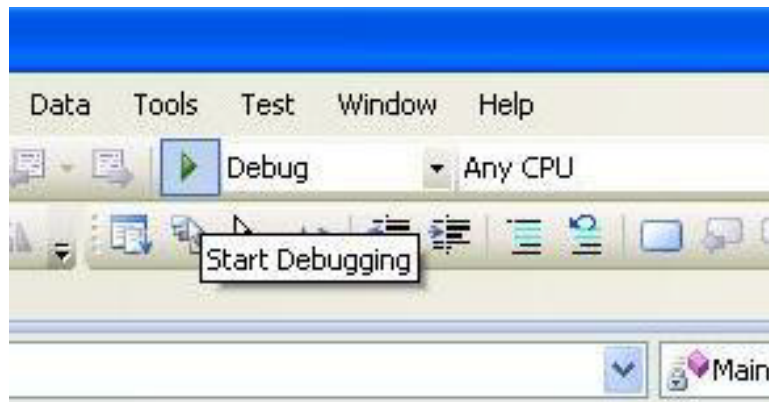

Figure 19. Run Debugger Icon

Although you previously set up the target device, upon starting the first debug session, you will be prompted to select the device to deploy the application to. Select the "Windows CE Device" as was done earlier when selecting the target. (See Figure 20.)



Figure 20. Target Deployment Dialog

Once the application is deployed to the SeaPAC R9-8.4, it will begin execution. As soon as the first breakpoint is reached, execution will cease, and you will gain full control over the running application. You may use the debugging options to continue execution, execute a single line, or execute multiple lines. You may view the status of each variable by either hovering over it with the cursor or by examining the windows at the bottom of Visual Studio just as you would with a desktop application. (See Figure 21.)

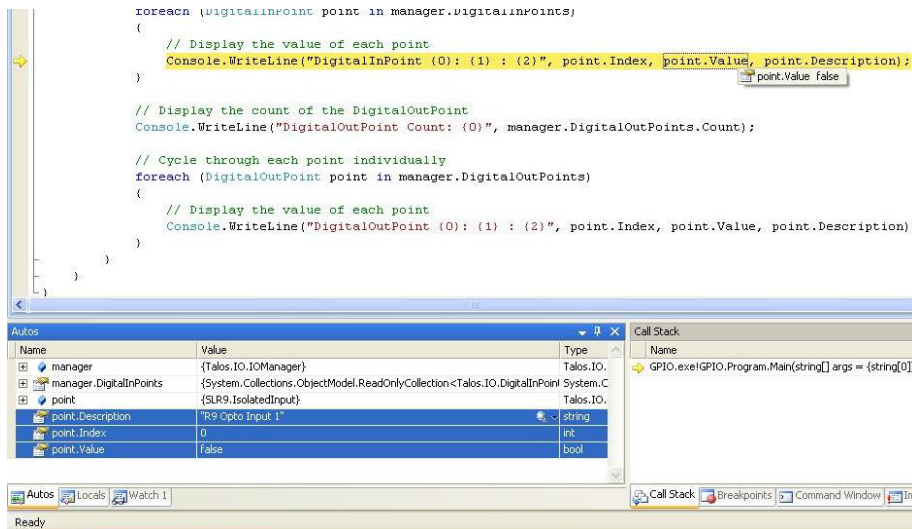

Watching Variables

When program execution is halted due to a break point condition being met, the debugger will display the state of all local variables. In addition to those variables, class specific variables can be grouped together as a view to aid in debugging your application. This is accomplished by right clicking on a variable and selecting "Add Watch". Each addition appends a tab to the "Watch n" window where n is incremented for each variable added. (See Figure 22.) Each watch window provides a convenient tree type structure for viewing hierarchical class variables.

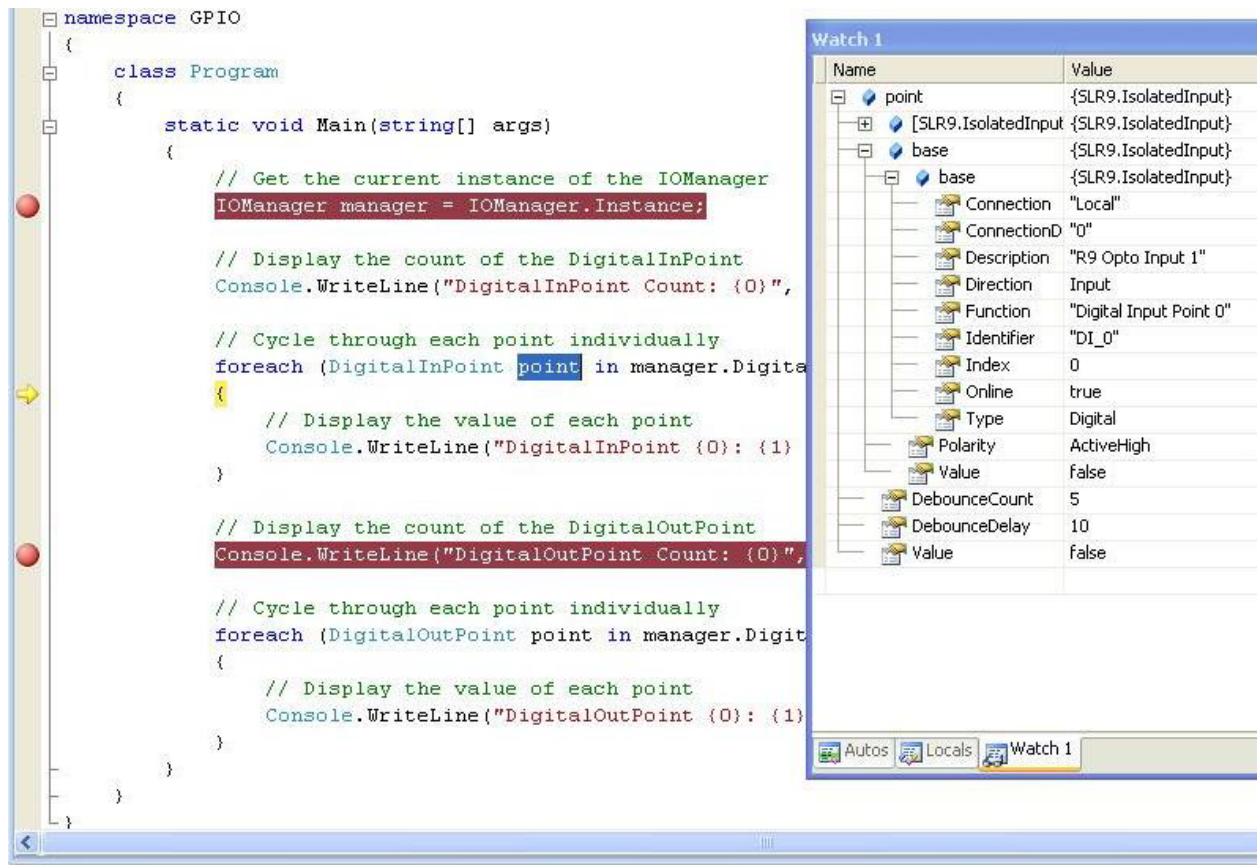

Figure 22. Watch View

Target Deployment and Execution

After your application is built using Visual Studio, either a debug or release executable, it may be desirable to copy it into NAND Flash. This would provide a means to store and execute your application without the need for connectivity to a host computer. The first step is transferring your application to a suitable directory in the on-board NAND Flash. To accomplish this you will need to establish connectivity via Windows Mobile Device Center or ActiveSync as outlined in the SeaPAC R9-8.4 Quick Start section above.

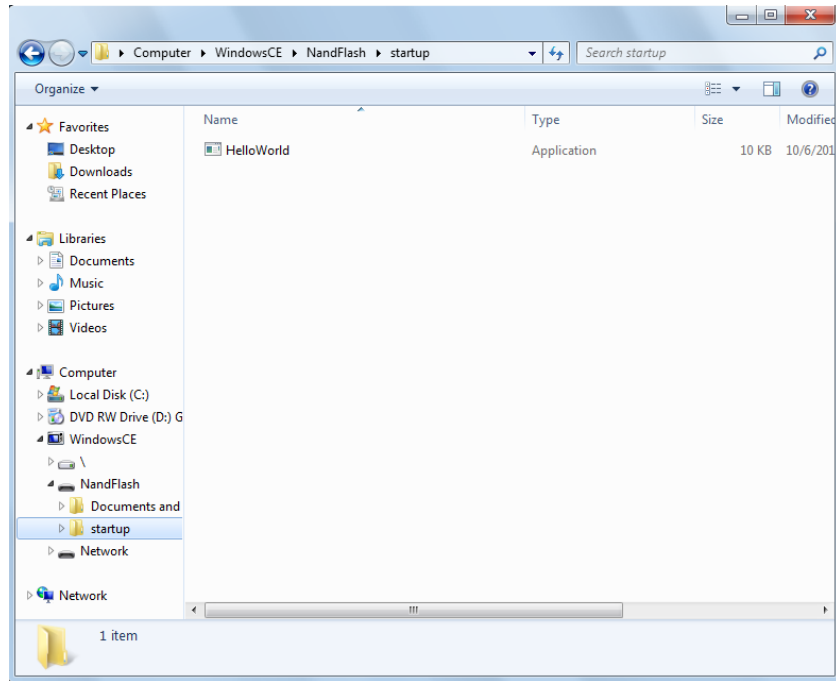

Figure 23. Application Placement

The SeaPAC R9-8.4 Runtime image comes pre-loaded with a utility program called “SpringBoard”. This utility provides a solution for automatically running your applications at startup. Rather than copying your application files to ‘/Windows/Startup/’ – which is in volatile memory – the executables should be copied to ‘/nandflash/startup/’. After Windows CE runs, SpringBoard automatically starts applications in this startup directory.

SpringBoard also provides a way to specify program arguments by supplying an XML configuration file. You will need to create a simple XML file called "startup.xml". This XML file should consist of an element list each with an application name and the desired arguments for that application. (See Figure 24.) This file must reside in the following location '/nandflash/startup/startup.xml'.



If the startup.xml file is not found or is not desired, SpringBoard will still automatically run all the applications placed in the aforementioned directory structure, only no arguments will be passed to those applications.

```
<?xml version="1.0" encoding="utf-8" ?>
<programs>
  <program name="sample1.exe" arguments="/i 1019 /w JSmith" />
  <program name="sample2.exe" arguments="-e 2000" />
  <program name="sample3.exe" arguments="/help" />
</programs>
```

Figure 24. startup.xml

Boot Sequence

Upon power-up, the SeaPAC R9-8.4 follows a specific boot sequence. The initial sequence is “firstboot”. The firstboot process initializes the low level hardware and is responsible for loading the next sequence called “eboot”. Eboot provides a configuration menu for setting connection types and start up memory locations. Connection types include Ethernet and USB. Memory location is NAND Flash. Ultimately, eboot attempts to load and execute the OS runtime image based on the configuration settings found here.

The SeaPAC R9-8.4 development board checks the raw data in the NAND Flash for a valid Eboot boot loader (eboot.nb0).

The SeaPAC R9-8.4 ships with a NAND Flash programmed with the OS binaries listed below:

- FIRSTBOOT.nb0
- Eboot.nb0
- NK.nb0

OS File Restoration

In the event that Sealevel produces updated OS file versions or a restore is desired, the OS files will need to be programmed to the NAND Flash. Please see the section labeled “Upgrading the OS runtime image on NAND Flash” below for more detail. The NAND Flash cannot be programmed until the existing OS runtime image has been removed. This can be accomplished through the debug port as described in the following section.

Using the Debug Port

This procedure requires an available RS-232 COM port or USB to RS-232 serial port adapter attached to a host PC, a SeaPAC R9 Serial Debug cable (Item# CA452), and any telnet terminal client application such as PuTTY (See Appendix A). For this procedure, we will demonstrate the use of PuTTY.

Connect one DB9 female end of the SeaPAC R9 serial debug cable into the SeaPAC R9-8.4 connector (labeled DBGU). Connect the DB9 end of the SeaPAC R9 serial debug cable into an available serial port on the host PC.



Run PuTTY and select “Serial” from the Category section of the dialog. Identify the proper COM port number and always assign the speed (baud) equal to 115200. Set Data bits to 8, Stop bits to 1, Parity to None, and Flow control to None. (See Figure 25.)

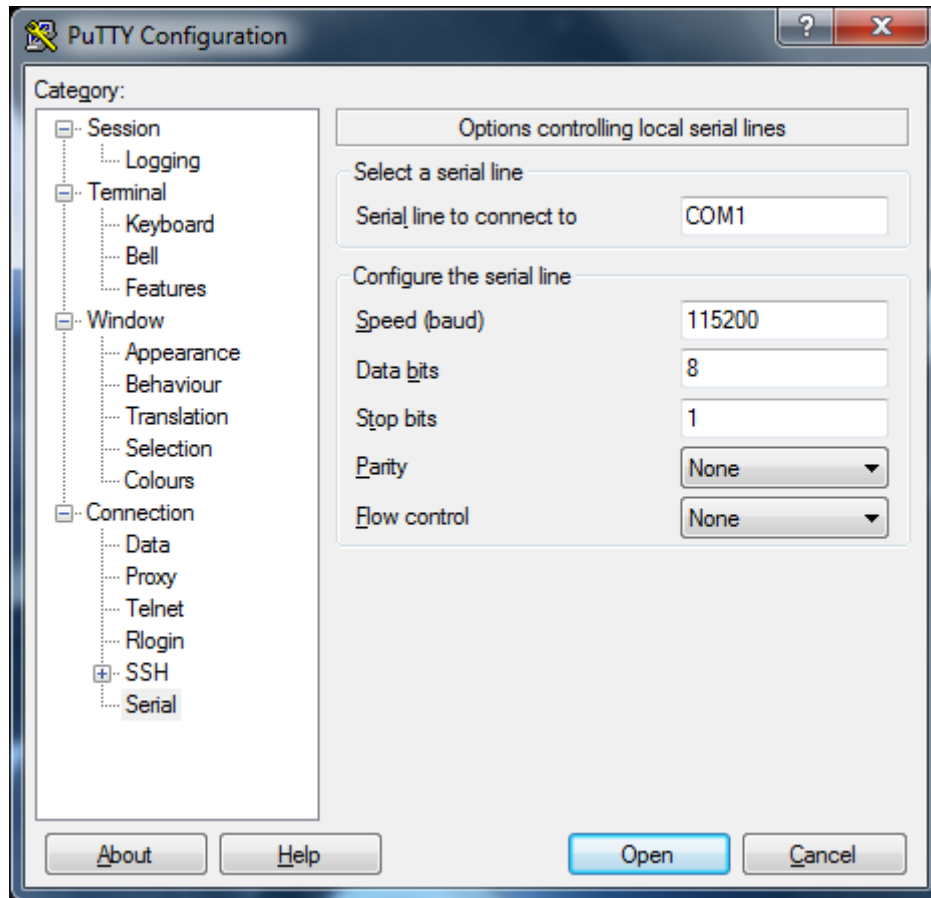

Figure 25. PuTTY Serial Configuration

Select “Session” from the Category section of the dialog. A saved session of this configuration can be performed to avoid reconfiguration in the future. Type a name for this session under “Saved Sessions”, then press the “Save” button. (See Figure 26.)

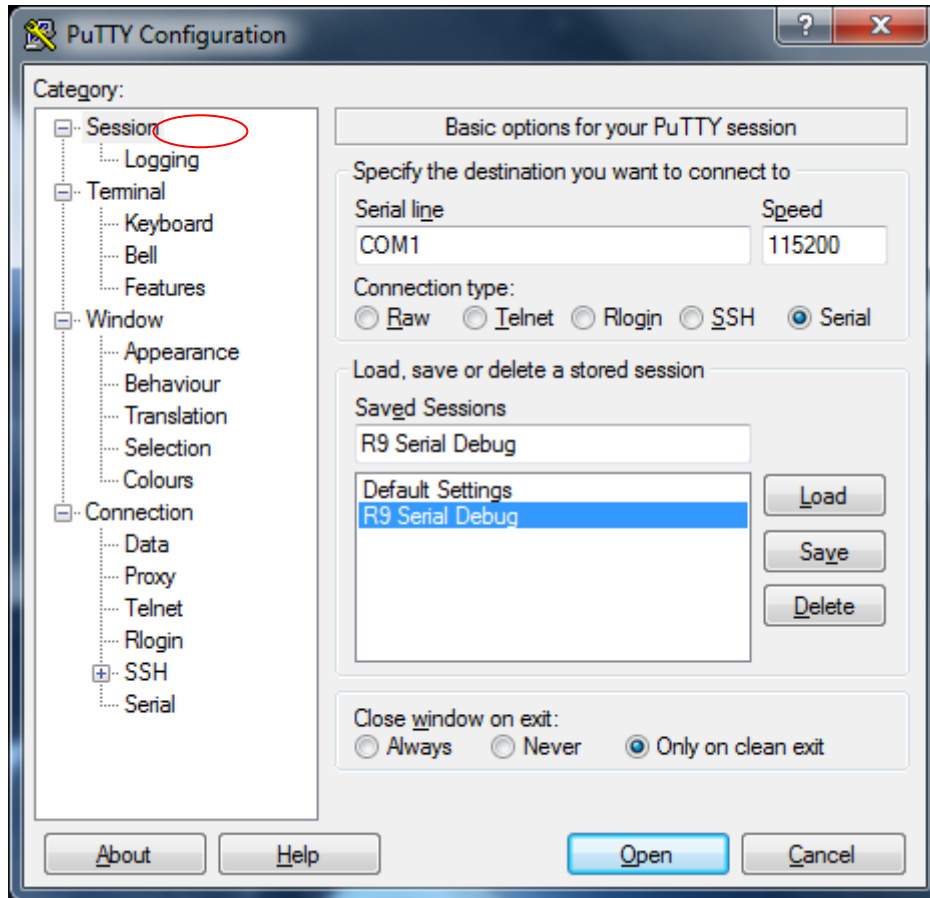
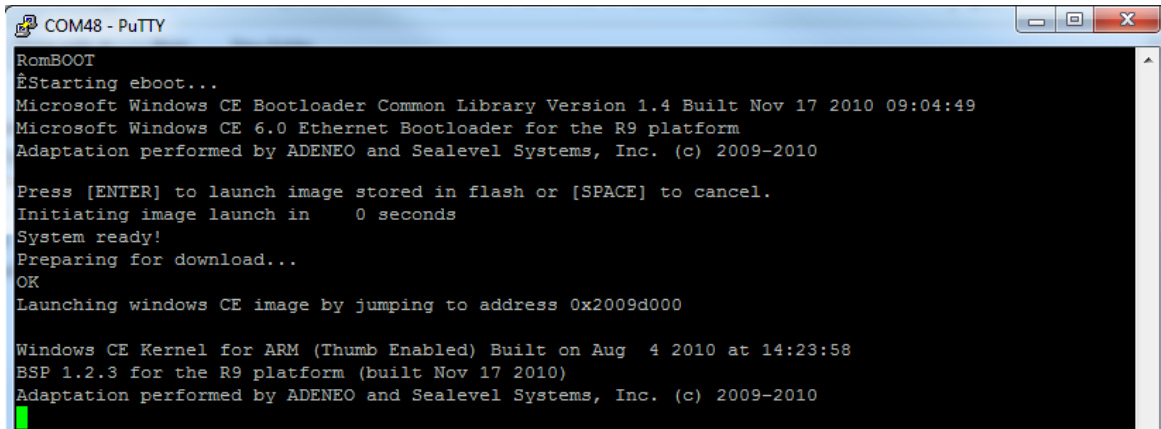

Figure 26. PuTTY Session Configuration

Press “Open” to start a new terminal session. A blank terminal window will appear. Debug messages may not appear until power is applied to the SeaPAC R9-8.4. Press the reset button on the SeaPAC R9-8.4 to display the Ethernet boot loader configuration screen. (See Figure 27.) When the unit boots, the following prompt on the debug port terminal will appear (no user input is required for booting):

```
“Press [ENTER] to download now or [SPACE] to cancel.  
Initiating image download in 2 seconds”
```

Once the prompt period expires, the OS runtime will be loaded from NAND Flash into RAM and executed. At this point, the OS is running. (See Figure 27.)



```
COM48 - PuTTY  
RomBOOT  
EStarting eboot...  
Microsoft Windows CE Bootloader Common Library Version 1.4 Built Nov 17 2010 09:04:49  
Microsoft Windows CE 6.0 Ethernet Bootloader for the R9 platform  
Adaptation performed by ADENEO and Sealevel Systems, Inc. (c) 2009-2010  
  
Press [ENTER] to launch image stored in flash or [SPACE] to cancel.  
Initiating image launch in 0 seconds  
System ready!  
Preparing for download...  
OK  
Launching windows CE image by jumping to address 0x2009d000  
  
Windows CE Kernel for ARM (Thumb Enabled) Built on Aug 4 2010 at 14:23:58  
BSP 1.2.3 for the R9 platform (built Nov 17 2010)  
Adaptation performed by ADENEO and Sealevel Systems, Inc. (c) 2009-2010
```

Figure 27. Application Debug Text Output



Eboot configuration settings can be modified by hitting the “space” key during the 2 second boot prompt period. When modifying the configuration, a menu such as the one below is displayed. (See Figure 28.)

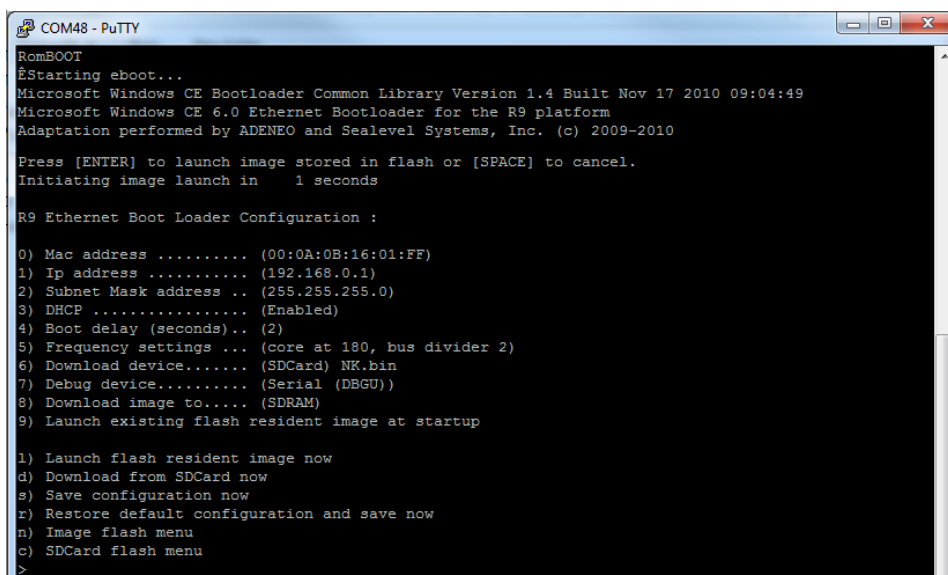

```
COM48 - PuTTY  
RomBOOT  
EStarting eboot...  
Microsoft Windows CE Bootloader Common Library Version 1.4 Built Nov 17 2010 09:04:49  
Microsoft Windows CE 6.0 Ethernet Bootloader for the R9 platform  
Adaptation performed by ADENEO and Sealevel Systems, Inc. (c) 2009-2010  
  
Press [ENTER] to launch image stored in flash or [SPACE] to cancel.  
Initiating image launch in 1 seconds  
  
R9 Ethernet Boot Loader Configuration :  
  
0) Mac address ..... (00:0A:0B:16:01:FF)  
1) Ip address ..... (192.168.0.1)  
2) Subnet Mask address .. (255.255.255.0)  
3) DHCP ..... (Enabled)  
4) Boot delay (seconds).. (2)  
5) Frequency settings ... (core at 180, bus divider 2)  
6) Download device..... (SDCard) NK.bin  
7) Debug device..... (Serial (DBGU))  
8) Download image to.... (SDRAM)  
9) Launch existing flash resident image at startup  
  
1) Launch flash resident image now  
d) Download from SDCard now  
s) Save configuration now  
r) Restore default configuration and save now  
n) Image flash menu  
c) SDCard flash menu  
>
```

Figure 28. Eboot Configuration Output



Modifying any of these settings may render your SeaPAC R9-8.4 unbootable

When upgrading an existing OS runtime it is necessary to first erase the NAND Flash of a pre-programmed unit. This is accomplished through the “Image flash menu” (“n’ key) in Eboot. The flash menu has an option to “Erase all sectors” of the NAND Flash (“1’ key). (See Figure 29.)

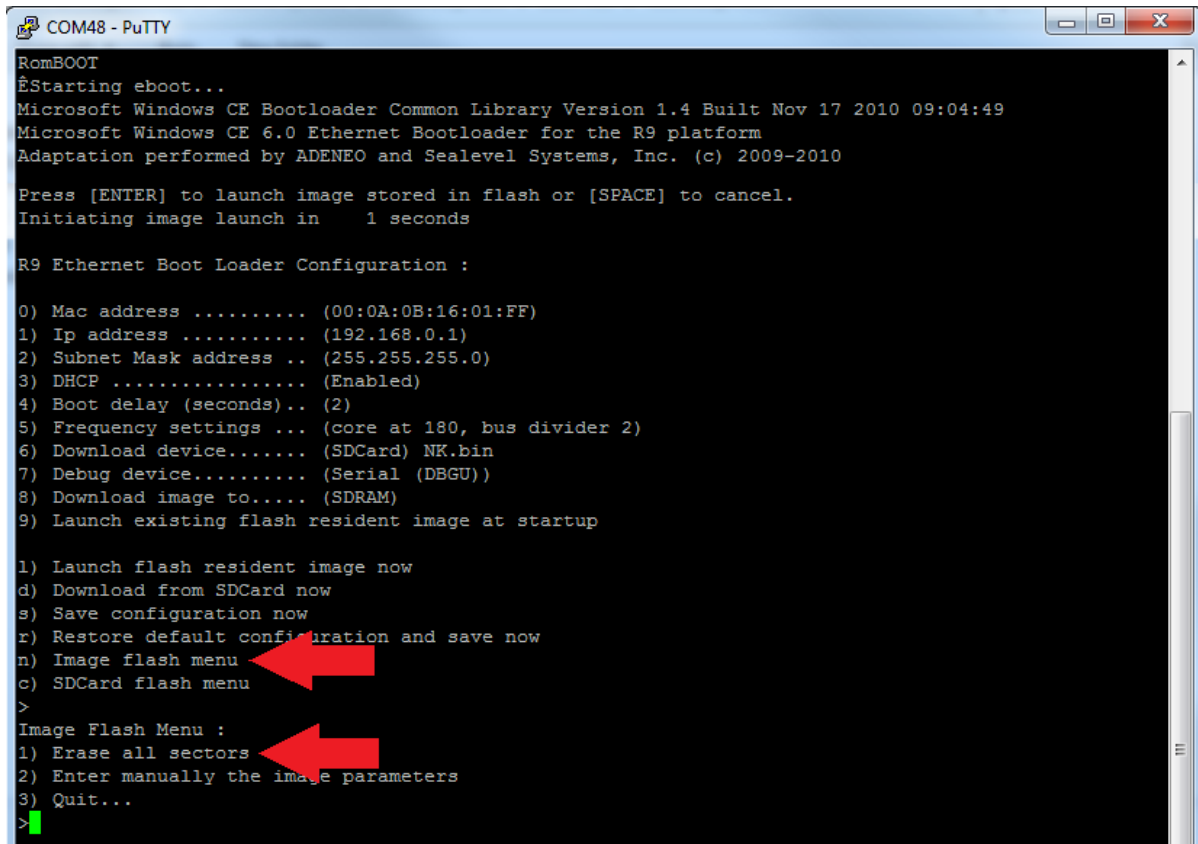

Figure 29. Eboot Image Flash Menu



The “Erase all sectors” option in Eboot will erase the entire NAND Flash, so be sure to back up any data you wish to save before attempting to erase the device.

Upgrading the OS Runtime Image on NAND Flash

Factory OS runtime images are stored in the “Boot Files” directory of the R9 Development installation (see Quick start guide). The OS runtime image present in the NAND Flash is programmed through the USB device port connection. Prior to programming an OS runtime, the existing image must be erased. The procedure to erase the NAND Flash is documented in the Debug Port section.

Once the NAND Flash has been erased, use a standard USB device cable and connect the Type B connector to the SeaPAC R9-8.4. Connect the Type A connector into the host PC. (See *Figure 30.*)



Figure 30. TR135 Tinned Leads and Type B USB Connector

In Microsoft Windows 7, the device is recognized as a GPS camera and will typically enumerate as a COM port. Verify the numeric assignment of the COM port in the device manager to determine the COM# associated with the device. If prompted with the Found New Hardware Wizard, install the driver using the following steps (Microsoft Windows XP dialog boxes are shown, other Microsoft Windows operating systems are similar). If your operating system prompts you to search Windows Update, choose “No, not this time”. Then, in the Found New Hardware Wizard, choose "Install from a list or specific location" and click Next. (See Figure 31.)



Figure 31. Found New Hardware Wizard

Select "Search for the best driver in these locations" and check "Include this location in the search". Use the Browse button to navigate to the "Utilities\SAM-BA\XP driver" directory of the R9 Development installation and click "Next".

The driver should be installed and will come in as "AT91 USB to Serial Converter." Click Finish to complete. (See Figure 32.)



Figure 32. Driver Installed

Determine COM port assignment using Device Manager > Ports. The USB function port should be listed. For Windows 7, it may be listed as a GPS camera, otherwise it should be “AT91 USB to Serial Converter.” Take note of the COM port assignment, to modify the programming batch file used to program the new OS Runtime image. (See Figure 33.)

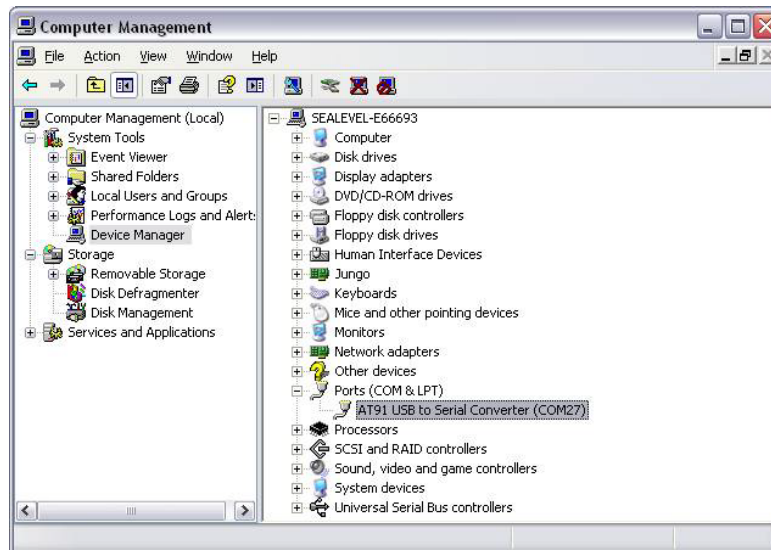

Figure 33. AT91 COM Port

Sample scripts have been provided in the R9 Development installation to automate the process of writing a complete OS runtime to the device. The script is configured to target a device attached to COM49 by default. This can be modified simply by editing the comport variable in the “NAND Program.bat” batch file. Once the batch file has been updated to reflect your system configuration, simply double-click the batch file to begin the programming process. The process will take a few minutes. (See Figure 34).

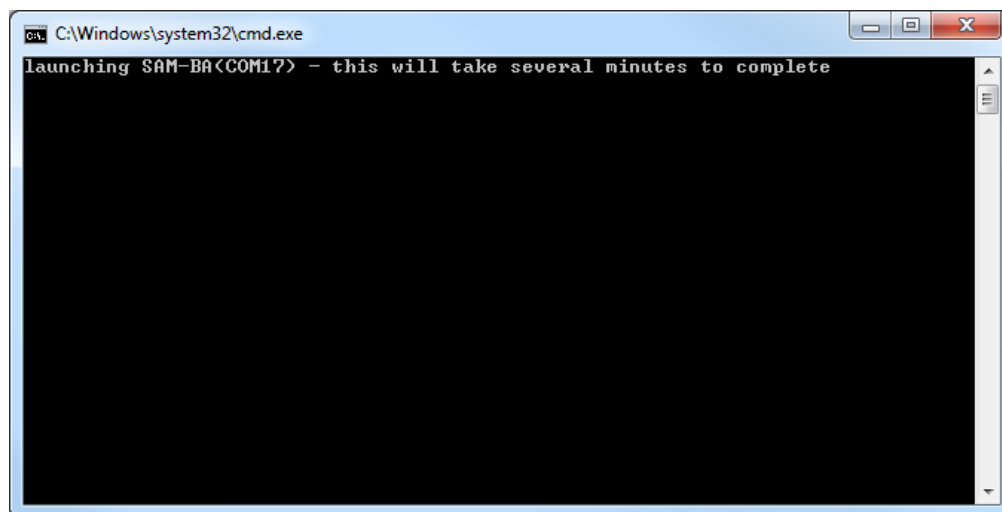

Figure 34. Programming NAND (COM17)

Once programming has completed, cycle device power and the OS runtime should boot. (See Figure 35.)

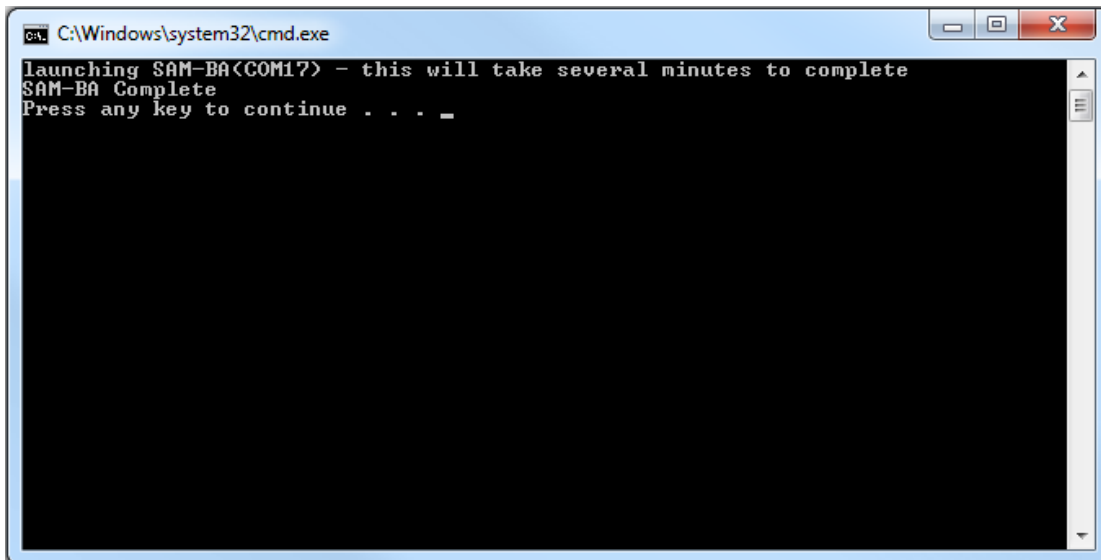

Figure 35. Programming Complete



As previously mentioned, the process of programming the NAND Flash first erases all content from the NAND Flash. This includes the unique MAC address assigned to your device at the factory. The "finalize.exe" tool is provided in the "Boot Files" directory of the R9 Development installation. Finalize is a command line utility that accepts a MAC address in dashed notation (00-0A-0B-16-12-34). The application should be executed on the device – this can be accomplished with rapistart, telnet, or locally in the device's Command Prompt - after reprogramming the NAND Flash to reassign the MAC address. Once the application has been executed, the setting is applied upon device restart and persists.

Network Configuration

The Windows CE that runs on the SeaPAC R9-8.4 is initially configured obtain its IP address via DHCP. Settings may be required for DNS or WINS server IP addresses or if you want to set up a static IP address. We have included an application in the OS that enables device configuration through a simple XML file format. The configuration is stored in a file that is kept up-to-date on the NAND Flash of the device. Likewise, edits to this file can be read as requests to modify the device's configuration. The configuration file can be accessed through ActiveSync using the USB device port connection or through an FTP client if you already know the IP address of the device. This section defines the XML configuration structure and corresponding values applicable for each element of the structure. Throughout this section the following definitions apply:

Term	Definition	Example
[int]	A number	123
[String]	Series of printable characters	This is a test string!234567609
[Multi-line String]	strings separated by \r\n	A\r\nNew\r\nMulti-liner
[Version]	A version number	1.2.3.4
[Boolean]	A binary state	True / False
[MACAddress]	A hardware identifier	00-0A-0B-16-11-1A
[IPAddress]	An IPv4 network address	192.168.0.100



The act of writing a new configuration file to the device will trigger a scan of that file (approximately every 5 seconds). If the file is invalid, it will be replaced with the current configuration. If a single element is invalid, that element and corresponding elements will be replaced with default values. To apply a new configuration, use the <Action> element with a value of "apply" as documented below.

```
<?xml version="1.0"?>
<Configuration>
  <System>
    <OS>WinCE</OS>
    <Version>6.0.0</Version>
    <Runtime>Proconex</Runtime>
    <RuntimeVersion>1.0.0.6</RuntimeVersion>
    <Processor>ATHEL, ARM926EJ-S-AT91SAM9263</Processor>
    <Name>WindowsCE</Name>
    <Description>WindowsCE Device</Description>
    <Owner></Owner>
    <Company></Company>
    <Address></Address>
    <Phone></Phone>
    <Extension></Extension>
  </System>
  <Ethernet>
    <Interface name="EMACB1">
      <DHCP>True</DHCP>
      <MAC>00-0A-0B-16-11-1A</MAC>
      <IPAddress>192.168.99.101</IPAddress>
      <Subnet>255.255.255.0</Subnet>
      <Gateway>192.168.99.1</Gateway>
      <Wifi enabled="True">
        <SSID>TESTNETWORK</SSID>
        <Mode>Infrastructure</Mode>
        <Channel>11</Channel>
        <Security>Wpa2Aes</Security>
        <Key encoding="Pass">*****</Key>
      </Wifi>
    </Interface>
  </Ethernet>
</Configuration>
```

Sample configuration.xml read from device.

<Configuration> -Structure

The configuration element is the root XML element. This element must be present, or the configuration file will not be considered valid. Invalid configurations will be replaced with a default configuration.

<System> -Structure

The system element contains all of the system information elements. This element must be present or the configuration file will not be considered valid.

<OS> - Readonly [string]

The OS element contains a string representation of the Operating System name. In the case of R9 products, this will be equivalent to "WinCE".

<Version> - Readonly [version]

The version element contains a dot-notation version string. This version is associated with the Operating System element.

<Runtime> - Readonly [string]

This element contains a string representation of the specific OS Runtime Image.

<*RuntimeVersion*> - Readonly [version]

This element contains a dot-notation version string. This version is associated with the OS Runtime Image.

<*Processor*> - Readonly [string]

This element contains a Processor Identification string.

<*Name*> - Read/Write [string]

This element may contain the device name string. This identifier is used as the WinCE host name.

<*Description*> - Read/Write [string]

This element may contain the device description string. This element can be used to further identify a device.

<*Owner*> - Read/Write [string]

This element may contain a string that can be used to identify a person or department responsible for maintaining a device.

<*Company*> - Read/Write [string]

This element may contain a string that can be used to identify the Company to which the device Owner is associated.

<*Address*> - Read/Write [multi-line string]

This element may contain a multi-line string (\r\n separated) to identify the location of the device Owner.

<*Phone*> - Read/Write [string]

This element may contain a string representation of a telephone contact number for the device Owner.

<*Extension*> - Read/Write [string]

This element may contain a string representation of a telephone extension for the device Owner.

<Ethernet> - Structure

The Ethernet element contains a list of Ethernet interfaces available to the device.

<Interface name=""> - Structure (Attribute Readonly [string])

The interface element is a container for the interface settings that are specific to the interface identifiable as "name". The name attribute is readonly and is used to uniquely distinguish Interface settings for the case where there are multiple Ethernet interfaces available.

<DHCP> - Read/Write [Boolean]

This element contains a Boolean value indicating whether DHCP Address resolution is enabled or disabled. Valid values are True or False.

<MAC> - Readonly [MACAddress]

This element contains a dash delimited string containing the unique MAC address of this interface. The first 3 octets identify the device as a Sealevel product (00-0A-0B). The fourth octet can be used to determine the product family (16). And the last two octets will be unique for each device (11-1A).

<IPAddress> - Read/Write [IPAddress]

This element may contain the current DHCP acquired IP Address or the current static IP address depending on the state of the DHCP element. Assigning a value to this element when DHCP is enabled has no effect.

<Subnet> - Read/Write [IPAddress]

This element may contain the current DHCP acquired Subnet Mask or the current static Subnet Mask depending on the state of the DHCP element. Assigning a value to this element when DHCP is enabled has no effect.

<Gateway> - Read/Write [IPAddress]

This element may contain the current DHCP acquired Gateway address or the current static Gateway address depending on the state of the DHCP element. Assigning a value to this element when DHCP is enabled has no effect.

<Wifi enabled=""> - Structure (Attribute Readonly)

The Wifi element is a container for wireless bridge settings if such a bridge is present. The "enabled" attribute will reflect whether the Interface is able to communicate with an approved wireless bridging module.

<SSID> - Read/Write [string]

This element contains the SSID string to be used when forming the wireless connection.

<Mode> - Read/Write [string: Adhoc, Infrastructure]

This element contains the overall Wireless configuration mode.

<Channel> - Read/Write [int: 1,11]

This element contains the wireless channel offset to use in Adhoc mode.

<Security> - Read/Write [string: None, WepOpen64, WepOpen128, WepShared64, WepShared128, WpaTkip, Wpa2Aes, Wpa2Tkip]

This element contains the security method for use in establishing the wireless connection.

<Key encoding=""> Writeonly [string] (Attribute [string: Hex, Ascii, Pass])

This key is used to set the wireless connection passphrase or value. Depending on the wireless configuration, the "encoding" attribute will need to be set accordingly. For security purposes this value cannot be read once it has been set.

<Action> - Writeonly [string]

This element may be used to trigger predetermined device behavior. For example, setting a value of "apply" to this element will result in the specified configuration being applied to the hardware and trigger a device restart so the settings will take effect.

Specifications

Physical Dimensions

Package Length	7.5 inches
Package Width *	5.1 inches
Package Height	1.3 inches



For CAD drawing with dimensions, see [Appendix C](#).

Power Requirements

Supply line	7 – 30 VDC Input
Rating	10 W Max (2.5W Nominal)

Connector	7-30VDC / GND on left side of enclosure
Manufacturer	Weco
Part Number:	121-M-211/02
Description:	2 Position Right Angle 5.08mm Header
Mates with:	RIA Connect ASP0460202 2 Position 5.08mm Pluggable Spring Clamp Terminal

Environmental Specifications

Specification	Operating	Storage
Temperature Range	-30° to 50° C	-60° to 105° C
Humidity Range	10 to 90% R.H. Non-Condensing	10 to 90% R.H. Non-Condensing

Certifications

NEMA 4X/IP65	In-house testing
Emissions	CE, FCC Class B
Safety	ETL EN/UL 60950-1

Manufacturing

All Sealevel Systems Printed Circuit boards are built to UL 94V0 rating and are 100% electrically tested. These printed circuit boards are solder mask over bare copper or solder mask over tin nickel.

Appendix A – Resources

Books

Professional Microsoft Windows Embedded CE 6.0, Wrox, Phung.

Programming Windows Embedded CE 6.0 Developer Reference, Microsoft Press, Boling.

<http://msdn.microsoft.com/en-us/library/cc526055.aspx>

Web Sites

Atmel SAM-BA In-System Programmer (ISP)

http://www.atmel.com/dyn/products/tools_card.asp?tool_id=3883

FileZilla Open-Source FTP Client

<http://www.filezilla-project.org>

Microsoft Windows Embedded Home Page

www.microsoft.com/windows/embedded/default.msp

What's New in Windows Embedded CE 6.0 R2

<http://msdn.microsoft.com/en-us/embedded/bb894656.aspx>

Microsoft Windows Embedded CE Operating System Components

<http://www.microsoft.com/windowseembedded/en-us/products/windowsce/component-library.msp#type>

Microsoft Windows Embedded CE 6.0 Evaluation Edition

<http://www.microsoft.com/downloads/details.aspx?familyid=7E286847-6E06-4A0C-8CAC-CA7D4C09CB56&displaylang=en>

Microsoft Windows CE 6.0 Bare Essentials Video

http://www.microsoft.com/video/en-us/details/ffe10273-38ec-4e4f-8ed8-a06174e2c5df?vp_evt=eref&vp_video=Windows+CE+6.0+Bare+Essentials

Microsoft Windows Embedded CE 6.0 Online Documentation

<http://msdn.microsoft.com/en-us/library/aa924073.aspx>

Microsoft Windows CE 6.0 Documentation Search Tool

http://search.live.com/macros/windows_embedded/ce6/?FORM=OIJG

Microsoft ActiveSync Download

<http://www.microsoft.com/windowsmobile/en-us/help/synchronize/ActiveSync-download.msp>

Microsoft Mobile Device Center 6.1

<http://www.microsoft.com/windowsmobile/en-us/downloads/microsoft/device-center-download.msp>

Microsoft .NET Compact Framework

<http://msdn.microsoft.com/en-us/netframework/aa497273.aspx>

PuTTY Telnet/SSH Client Application

<http://en.wikipedia.org/wiki/PuTTY>

Appendix B – Application Debugging over Ethernet

Applications can be debugged over an Ethernet connection in place of USB by configuring Visual Studio to directly connect to your device. For this method to work properly, the Ethernet connection to the device must be properly configured to allow normal TCP/IP communications and you must know the IP address of the device you wish to execute the application on. For further information about configuring the Ethernet of the device see the Network Configuration section.

To configure Visual Studio to use your device for debugging over Ethernet, click the “Device Options” button on the Device toolbar. See below.



On the “Device Options” dialog, select the “Windows CE” platform and click the “Properties...” button. See below.

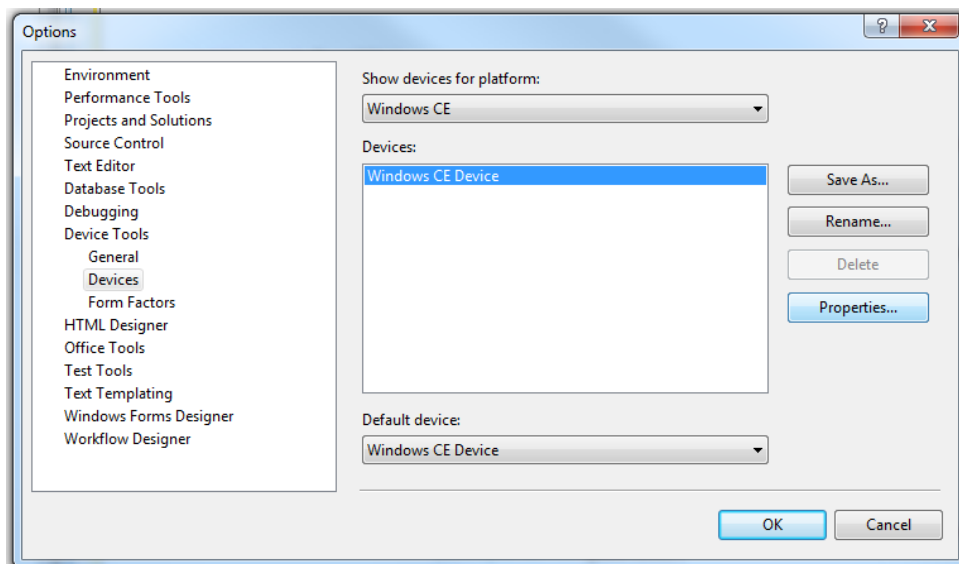

On the “Windows CE Device” properties dialog click the “Configure...” button. See below.

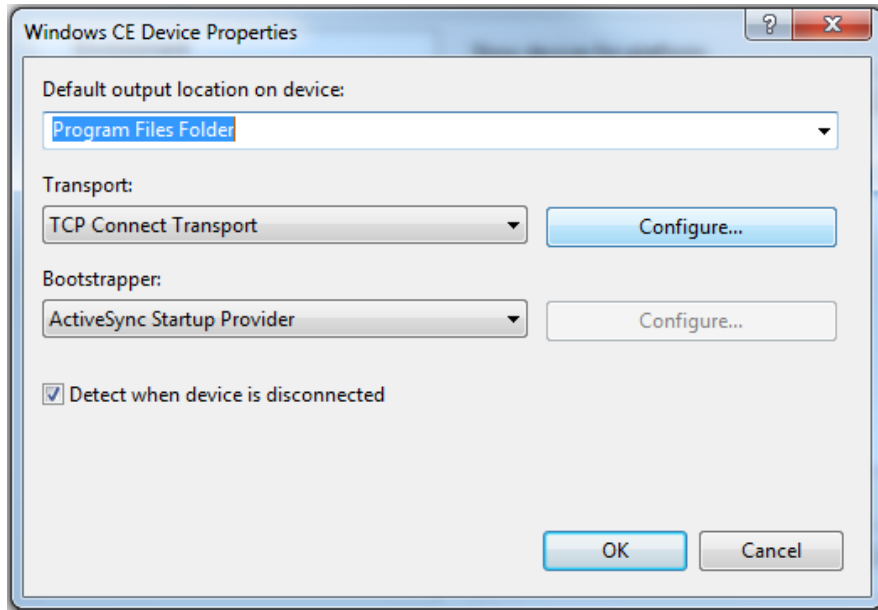

Now click the “Use specific IP address” radio button and type the IP address of the device in the text box. See below.

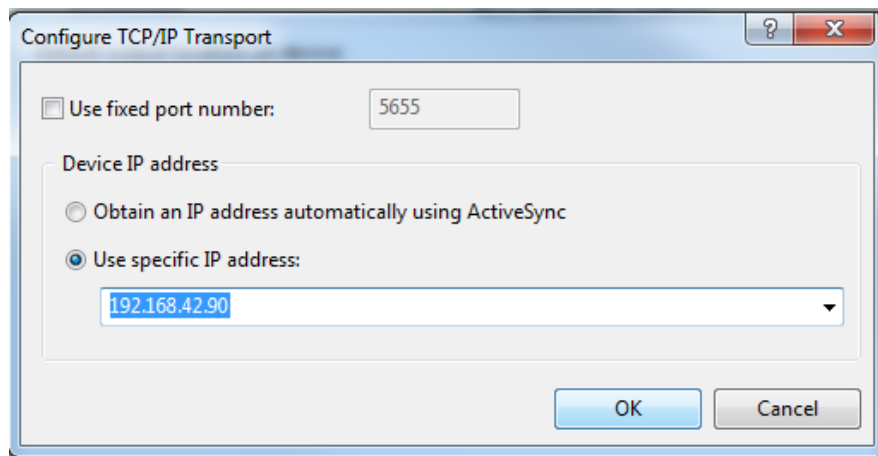

Click the “OK” button on all of the dialog windows and you should now be able to connect to the device through Ethernet for debugging. The application debugging guide can be continued as normal.

Appendix C – CAD Drawing

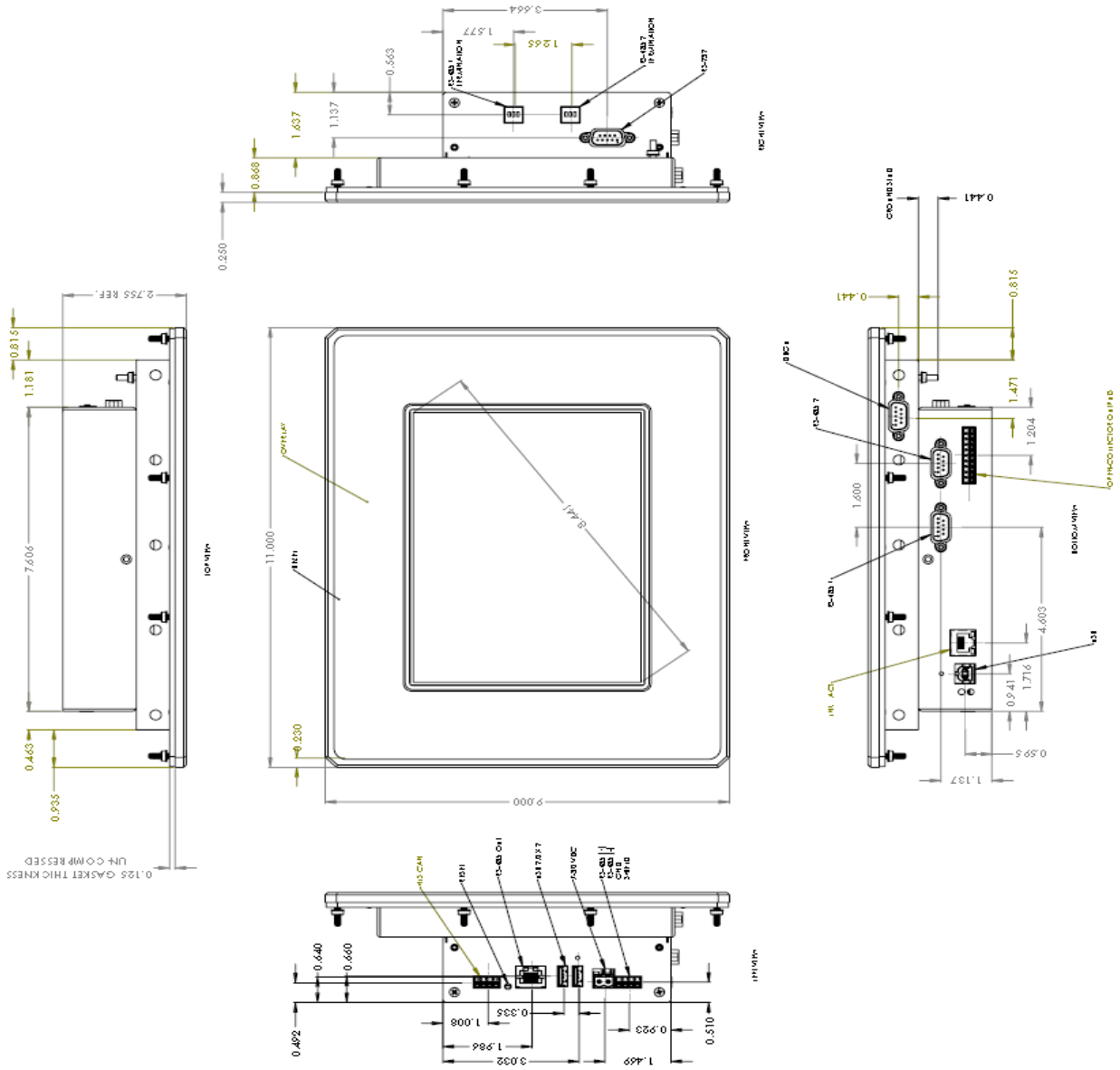

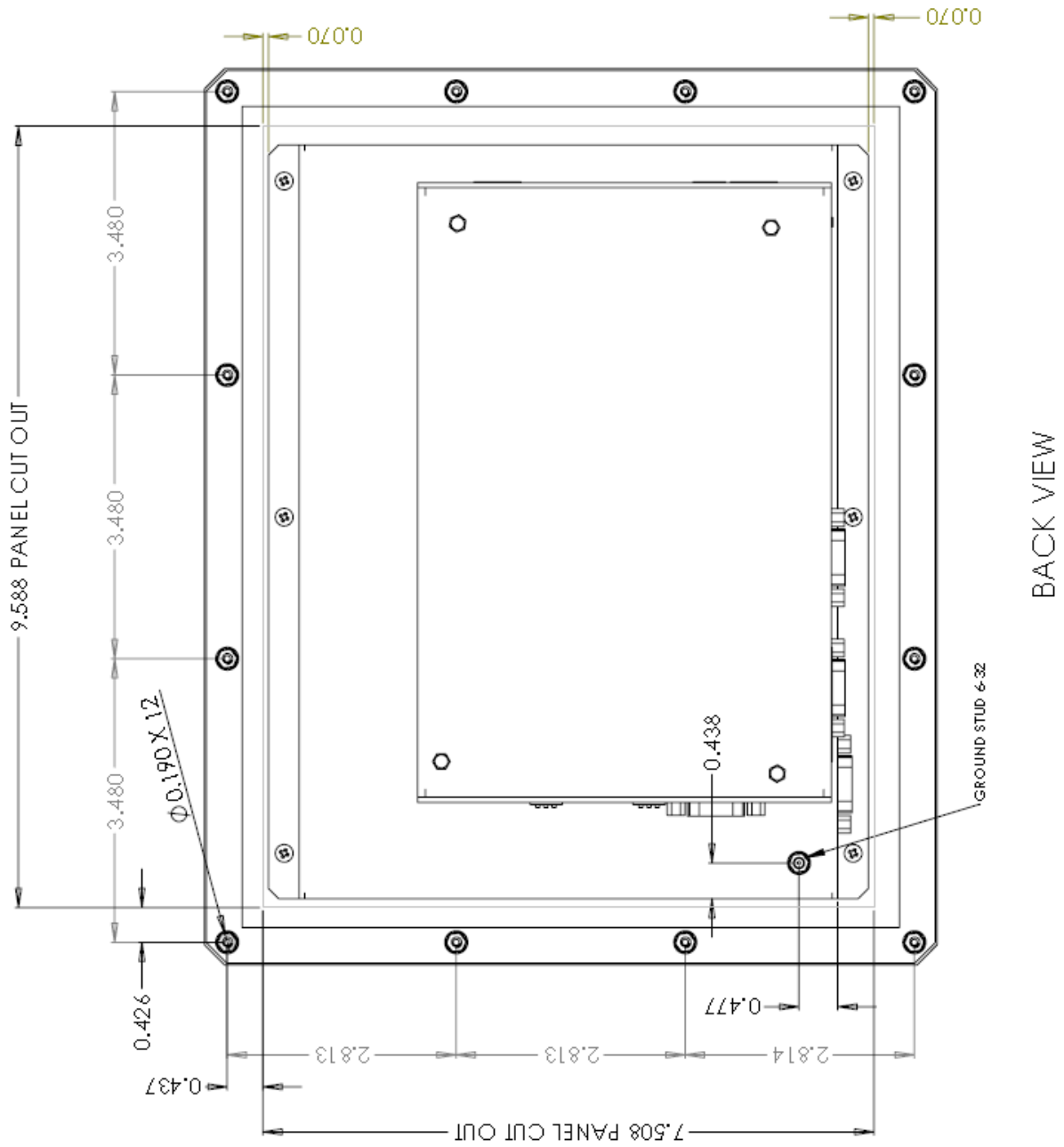

Appendix D – How To Get Assistance

Please refer to: [Appendix A](#) – Troubleshooting Guide prior to calling Technical Support.

Begin by reading through the Trouble Shooting Guide in Appendix A. If assistance is still needed, please see below.

When calling for technical assistance, please have your user manual and current adapter settings. If possible, please have the adapter installed in a computer ready to run diagnostics.

Sealevel Systems provides an FAQ section on its web site. Please refer to this to answer many common questions. This section can be found at <http://www.sealevel.com/faq.asp>.

Sealevel Systems maintains a web page on the Internet. Our home page address is www.sealevel.com. The latest software updates, and newest manuals are available via our web site.

Technical support is available Monday to Friday from 8:00 AM to 5:00 PM Eastern Time. Technical support can be reached at (864) 843-4343.

RETURN AUTHORIZATION MUST BE OBTAINED FROM SEALEVEL SYSTEMS BEFORE RETURNED MERCHANDISE WILL BE ACCEPTED. AUTHORIZATION CAN BE OBTAINED BY CALLING SEALEVEL SYSTEMS AND REQUESTING A RETURN MERCHANDISE AUTHORIZATION (RMA) NUMBER.

Warranty

Sealevel's commitment to providing the best I/O solutions is reflected in the Lifetime Warranty that is standard on all Sealevel manufactured I/O products. We are able to offer this warranty due to our control of manufacturing quality and the historically high reliability of our products in the field. Sealevel products are designed and manufactured at its Liberty, South Carolina facility, allowing direct control over product development, production, burn-in and testing. Sealevel achieved ISO-9001:2015 certification in 2018.

Warranty Policy

Sealevel Systems, Inc. (hereafter "Sealevel") warrants that the Product shall conform to and perform in accordance with published technical specifications and shall be free of defects in materials and workmanship for the warranty period. In the event of failure, Sealevel will repair or replace the product at Sealevel's sole discretion. Failures resulting from misapplication or misuse of the Product, failure to adhere to any specifications or instructions, or failure resulting from neglect, abuse, accidents, or acts of nature are not covered under this warranty.

Warranty service may be obtained by delivering the Product to Sealevel and providing proof of purchase. Customer agrees to ensure the Product or assume the risk of loss or damage in transit, to prepay shipping charges to Sealevel, and to use the original shipping container or equivalent. Warranty is valid only for original purchaser and is not transferable.

This warranty applies to Sealevel manufactured Product. Product purchased through Sealevel but manufactured by a third party will retain the original manufacturer's warranty.

Non-Warranty Repair/Retest

Products returned due to damage or misuse and Products retested with no problem found are subject to repair/retest charges. A purchase order or credit card number and authorization must be provided in order to obtain an RMA (Return Merchandise Authorization) number prior to returning Product.

How to obtain an RMA (Return Merchandise Authorization)

If you need to return a product for warranty or non-warranty repair, you must first obtain an RMA number. Please contact Sealevel Systems, Inc. Technical Support for assistance:

Available	Monday – Friday, 8:00AM to 5:00PM EST
Phone	864-843-4343
Email	support@sealevel.com

Trademarks

Sealevel Systems, Incorporated acknowledges that all trademarks referenced in this manual are the service mark, trademark, or registered trademark of the respective company.