

# REL-16.PCIe

User Manual | 8003e

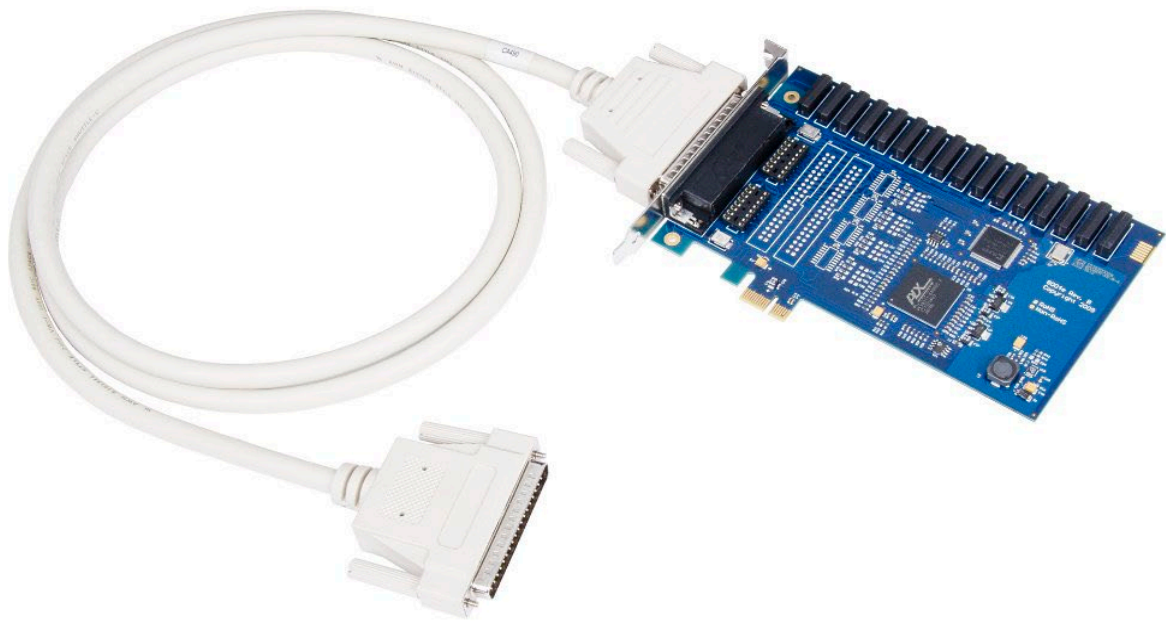

**SEALEVEL®**

# Contents

- CONTENTS..... 2
- BEFORE YOU GET STARTED ..... 3
- INTRODUCTION ..... 4
- ELECTRICAL SPECIFICATIONS..... 7
- TECHNICAL SPECIFICATIONS..... 8
- HARDWARE INSTALLATION ..... 9
- PROGRAMMING THE REL-16.PCIE..... 11
- EXAMPLE CIRCUITS ..... 15
- SOFTWARE INSTALLATION ..... 16
- APPENDIX A – HANDLING INSTRUCTIONS ..... 17
- APPENDIX B – TROUBLESHOOTING..... 18
- APPENDIX C – HOW TO GET ASSISTANCE..... 21
- APPENDIX D – DRAWING..... 22
- APPENDIX E – COMPLIANCE NOTICES..... 23
- WARRANTY ..... 24

# Before You Get Started

## What's Included

The 8003e is shipped with the following items. If any of these items are missing or damaged, please contact Sealevel for replacement.

- **8003e -REL-16.PCie Digital I/O Adapter**
- **DB78 Male to DB37 Male cable (Item# CA490)**

## Advisory Conventions



### Warning

The highest level of importance used to stress a condition where damage could result to the product, or the user could suffer serious injury.



### Important

The middle level of importance used to highlight information that might not seem obvious or a situation that could cause the product to fail.



### Note

The lowest level of importance used to provide background information, additional tips, or other non-critical facts that will not affect the use of the product.

# Introduction

## Product Description

The REL-16.PCIe provides 16 reed relay outputs. The outputs provide high quality, long life, low current (10 Watt maximum), dry contact switch closures. Reed relays are well suited for low current applications. The relays are normally open, and close when energized.

The Seal/O Classic software drivers and utilities make installation and operation easy using Windows 7, Vista, and XP operating systems. The Seal/O API (Application Programmer Interface) provides a variety of useful high-level function calls implemented as a Windows dynamic link library (DLL) and as a Linux kernel module and library. Seal/O also includes sample code and utilities to simplify software development.

## Features

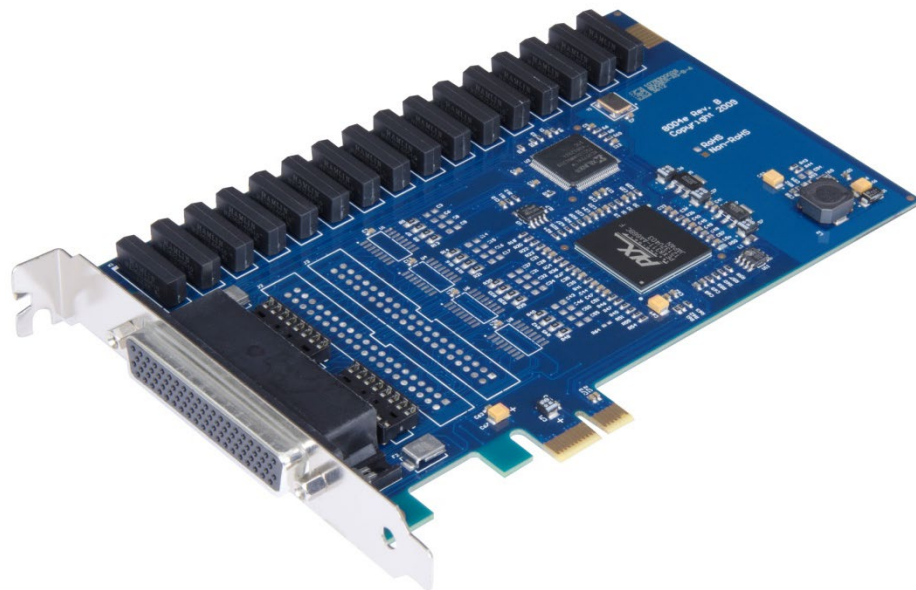

- PCI Express X1 compliant
- 16 Reed relay outputs (SPST)
- Highly reliable 10VA Reed relays
- Power (+5V and +12V) and ground provided on DB78 board connector
- Includes 72" cable with DB78 Male connector to DB37 Maleconnectors (Item# CA490)
- Seal/O Classic software supports Windows 7, Vista, and XP operating systems
- Software support for Linux available



## Optional Items



Depending upon your application, you are likely to find one or more of the following items useful with the 8003e. All items can be purchased from our website ([www.sealevel.com](http://www.sealevel.com)) by calling our sales team at (864) 843-4343.

## Cables

<b>DB37 Male to DB37 Female Extension Cable (Item# CA112)</b>	
This cable provides a 6' extension to the CA490. It has one DB37 Male connector and one DB37 Female connector.	
<b>DB78 Male to DB78 Female Extension Cable (Item# CA233)</b>	
This cable provides a 6' extension to the DB78 board connector on the 8006e. It has one DB78 Male connector and one DB78 Female connector.	
<b>DB78 Male to (1) DB37 Male (Output) Cable (Item# CA490)</b>	
The CA490 is a 72-inch cable with a DB78 male connector that is compatible with the board connector on the 8003e. The other end of the cable terminates in a DB37 male connector for digital outputs. This is the replacement for the cable that ships with the 8003e PCI Express digital I/O interface.	

## OPTIONAL ITEMS, CONTINUED

### Terminal Blocks

DB37 Terminal Block (Item# TB02-KT)	
<p>The TB02-KT terminal block can be used to break out serial and digital DB37 connectors to screw terminals for easy field wiring. The terminal block was designed with both DB37 male and female connectors, therefore; it can be used with any DB37 board regardless of the board's port gender.</p> <p>The TB02-KT ships with a RoHS compliant TB02 terminal block, a 6 piece of slotted Snap Track, and two DIN-rail mounting clips.</p>	
Terminal Block Kit – TB02 + CA112 Cable (Item# KT101)	
<p>Terminal Block KT101 includes the TB02 and CA112 (DB37 M/F cable). This cable kit can be used with both 37 pin Digital I/O and Serial I/O products.</p>	

### Books

The Digital I/O Handbook - A Practical Guide to Industrial Input and Output Applications (Item# REF101)	
<p>Renowned technical author Jon Titus and the President and CEO of Sealevel Systems, Tom O'Hanlan, clearly explain real-world digital input/output implementation from both a hardware and software perspective. Whether you are a practicing engineer or a student, The Digital I/O Handbook will provide helpful insight you will use again and again.</p>	

# Electrical Specifications

## Features

- 2 I/O ports with each having 8 SPST relays
- DB-37 Male connector for relay outputs
- Highly reliable 10 VA reed relays
- Multiple adapters can reside in same computer

## Output Relays

<b>Contact Max Power Rating</b>	10 W
<b>Contact Voltage Maximum</b>	60 VDC (or peak VAC)
<b>Contact Current Maximum</b>	.5A AC/DC RMS
<b>Contact Resistance, Initial</b>	.15 $\Omega$
<b>Contact Speed</b>	
– Operate	.5 mS
– Release	.5 mS
– Bounce	.5 mS
<b>Maximum Operating Speed</b>	600Hz

# Technical Specifications

## Physical Dimensions

<b>Package Length</b>	6.5 inches (16.5 cm)
<b>Package Height</b>	4.2 inches (10.7 cm)

## Environmental Specifications

<b>Specification</b>	<b>Operating</b>	<b>Storage</b>
<b>Temperature Range</b>	0° to 70° C (32° to 158° F)	-50° to 105° C (-58° to 221° F)
<b>Humidity Range</b>	10 to 90% R.H. Non-Condensing	10 to 90% R.H. Non-Condensing

## Manufacturing

All Sealevel Systems Printed Circuit boards are built to UL 94V0 rating and are 100% electrically tested. These printed circuit boards are solder mask over bare copper or solder mask over tin nickel.



# Hardware Installation



Do not install the PCI Express board until the software has been successfully installed.

The **REL-16.PCIe** does not need to be configured prior to installation.

Once you have installed the Seal/O Classic software, install the board into an available PCI Express slot and boot the computer. The Found New Hardware wizard will appear. The drivers that were installed during the software installation process will automatically be used to configure the adapter.

The following instructions are applicable to the Windows XP operating system and may vary depending on your version of Windows. If you are using the Microsoft Windows 7 operating system, the installation is automatic.

1. After the software installation is complete, shut down the PC. Install the REL-16.PCIe into an available PCI Express slot and boot the computer.
2. A 'Found New Hardware' alert will appear above the system tray.

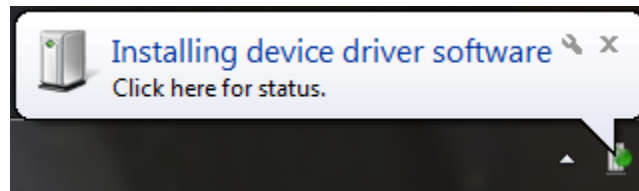

3. When the 'Found New Hardware' alert informs you that your hardware is installed and ready to use, you can proceed with verifying the installation to check functionality if necessary.

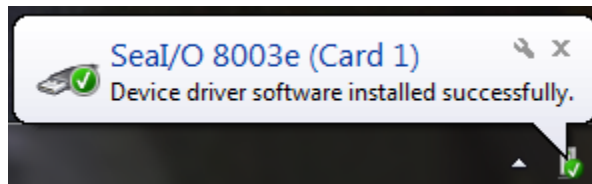

## Verifying Installation

To confirm that the digital I/O card has been successfully installed and recognized by your operating system, look in the Windows Device Manager.

To access Device Manager, follow the steps below:

Right click on 'Computer' icon on your desktop or in the Start menu.

1. Click 'Manage' in the fly out menu to launch the 'Computer Management' console window.
2. In the left pane under 'System Tools', click 'Device Manager'.
3. In right pane near the bottom, expand the 'Seal/O Device' section by clicking the '+' symbol. This shows the parent device is installed correctly.
4. You should see the card assignment listed as 'Seal/O 8003e' with the card number in parentheses. The card number will increment for each additional Seal/O device installed.

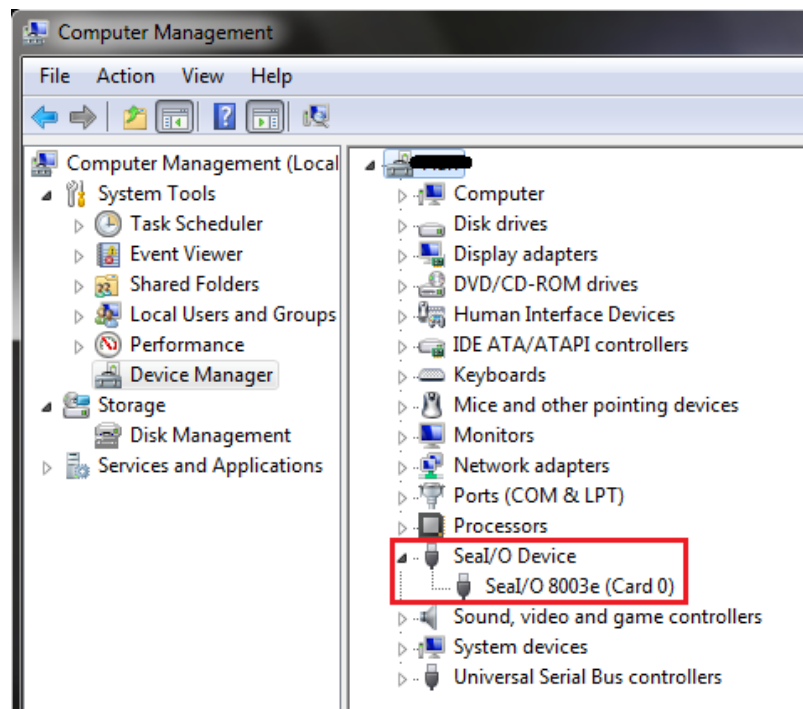

The REL-16.PCIe is now ready for use.

# Programming the REL-16.PCIe

Sealevel's Seal/O Classic software is provided to assist in the development of reliable applications for the Sealevel Systems family of PCI and PCI Express digital I/O adapters. The Seal/O Classic software is available on Sealevel's website. The software contains driver functions for use in accessing the I/O as well as helpful samples and utilities.

## Programming for Windows

The Seal/O Classic API (Application Programmer Interface) provides a variety of useful high-level function calls implemented in a Windows dynamic link library (DLL). The API is defined in the help file (Start/Programs/SealO/SealO Help) under "Application Programmers Interface". This help file also includes detailed information dealing with installation / removal of the software and information about latency, logic states, and device configuration.

For C language programmers we recommend using the API to access the REL-16.PCIe. If you are programming in Visual Basic 6 or earlier, using the ActiveX control included with Seal/O is advised.

## Samples and Utilities

A variety of sample programs and utilities (both executable and source code) are included with Seal/O. Further documentation on these samples can be found by selecting "Start/Programs/SealO/Sample Application Description". Information about where the files are physically stored on your disk is also included in this same file.

## Programming for Linux

Seal/O for Linux consists of two major parts: a kernel module and a library. The kernel module is a simple IO pass-through device, allowing the library to handle the more sophisticated functions provided to Seal/O users. It is provided in a 'tarball' format and can easily be compiled and included in the kernel build.

## Digital I/O Interface

The REL-16.PCIe provides two parallel output ports. The ports are organized as ports A and B. Ports A and B are reed relay output ports. Assuming an I/O address of 4000 Hex the following table shows the Port Addresses.

Base Address	Hex	Decimal	Mode
Port A Address	4002	16386	Reed Relay Output Port
Port B Address	4003	16387	

## Output Ports (Reed Relay)

Reed relays provide very high quality, long life, low current (10 Watt maximum), dry contact switch closures. Reed relays are not suited for high current applications, and can be destroyed by inductive load switching, where a spark occurs across the contacts internally. The relays are normally open, and close when energized.

## Output Ports (Reed Relay) Pin Assignments (DB-37 Male)

Outputs are interfaced via the DB-37 male connector on the supplied CA490 cable.

Signal Name	Port A Output Pin Pairs
Port A Bit 0	2,20
Port A Bit 1	3,21
Port A Bit 2	4,22
Port A Bit 3	5,23
Port A Bit 4	6,24
Port A Bit 5	7,25
Port A Bit 6	8,26
Port A Bit 7	9,27
Port B Bit 0	10,28
Port B Bit 1	11,29
Port B Bit 2	12,30
Port B Bit 3	13,31
Port B Bit 4	14,32
Port B Bit 5	15,33
Port B Bit 6	16,34
Port B Bit 7	17,35
Ground	18,36,37
+ 5 Volts	19
+ 12 Volts	1

## DB-78 Female Pin Assignments (Card Edge Connector)

Bit	Port A Pins	Port B Pins
0	2,20	10,28
1	3,21	11,29
2	4,22	12,30
3	5,23	13,31
4	6,24	14,32
5	7,25	15,33
6	8,26	16,34
7	9,27	17,35

GND	39,57,58	18,36,37
+12V	38	1
+5V	56	19

## Direct Hardware Control

In systems where the user's program has direct access to the hardware (DOS) the tables that follow give the mapping and functions that the REL-16.PCIe provides.

Function Available	Port	Address Hex	Port Type
RD/WR	A	Base + 2	Reed Relay Output Port
RD/WR	B	Base + 3	

RD/WR = Read or Write

## Reading the Outputs

The relay ports return the ones complement of the value that is currently being used to drive the relays.

## Writing the Outputs

The output ports are the only ports that can be written. The relays on a standard REL-16.PCIe are normally open. To close a relay a one must be written to the appropriate bit.

## Register Description

Address		Mode	D7	D6	D5	D4	D3	D2	D1	D0
Base+2	Output Port A	RD/WR	PCD7	PCD6	PCD5	PCD4	PCD3	PCD2	PCD1	PCD0
Base+3	Output Port B	RD/WR	PDD7	PDD6	PDD5	PDD4	PDD3	PDD2	PDD1	PDD0

# Example Circuits

## OUTPUT CIRCUIT

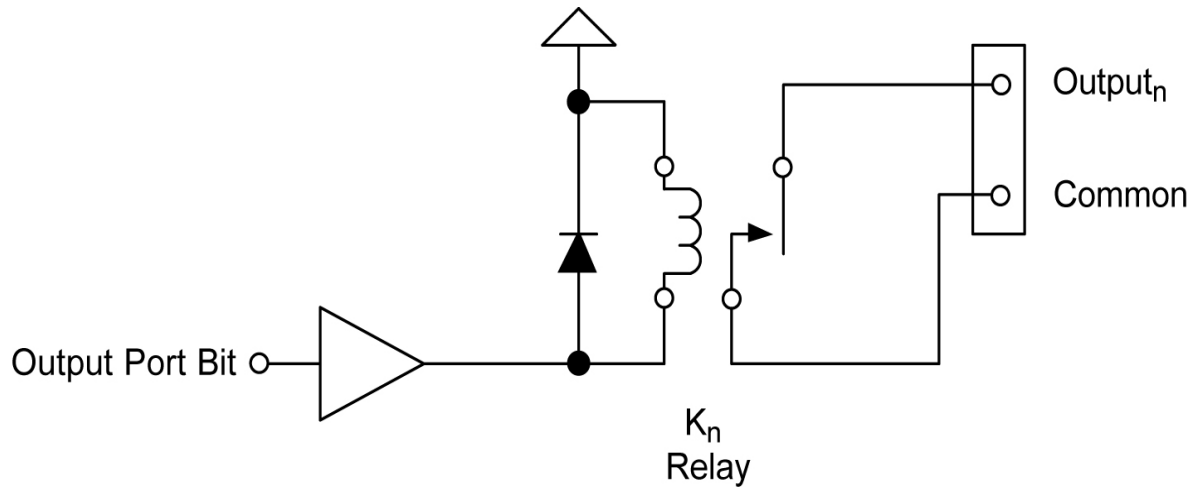

In the above circuit diagram, Output<sub>n</sub> is one of the two Output Pair Pins from the table labeled Output Ports Pin Assignments. Common is the other pin listed in Output Pair Pins. Since this is an isolated output, the polarity is not important.

# Software Installation

## Operating System Installation

### For Windows and Linux Users

This section contains helpful information pertaining to the installation of supported Sealevel Systems, Inc. software packages. First, the process of acquiring the software is discussed. Next, the installation is detailed in a step-by-step guide for Windows and Linux operating systems. Refer to the [SealO Software Overview page](#).

1. Sealevel software for Windows and Linux operating systems is available at these links:
  - [Software for Windows](#)
  - [Software for Linux](#)
2. Choose the link for the desired software package and click on the 'Download File' link to download the current driver.
3. Proceed to the Manual Software Installation guide for your operating system.

Seal/O software can also be downloaded from the 8003e-product webpage: [REL-16.PCIe](#)

### Other Operating Systems

Refer to the appropriate section of the Serial Utilities Software.

For additional software support, please call Sealevel Systems' Technical Support, (864) 843-4343. Our technical support is free and available from 8:00AM-5PM Eastern Time, Monday through Friday. For email support contact: [support@sealevel.com](mailto:support@sealevel.com).



Do not connect the hardware until the software has been successfully installed.



To install Sealevel software, you must log in as an administrator or have administrator privileges in Windows.



All command syntax is case sensitive.



# Appendix A – Handling Instructions

## ESD Warnings

### Electrostatic Discharges (ESD)

A sudden electrostatic discharge can destroy sensitive components. Proper packaging and grounding rules must therefore be observed. Always take the following precautions:

- Transport boards and cards in electrostatically secure containers or bags.
- Keep electrostatically sensitive components in their containers, until they arrive at an electrostatically protected workplace.
- Only touch electrostatically sensitive components when you are properly grounded.
- Store electrostatically sensitive components in protective packaging or on anti-static mats.

### Grounding Methods

The following measures help to avoid electrostatic damages to the device:

- Cover workstations with approved antistatic material. Always wear a wrist strap connected to a properly grounded workplace.
- Use antistatic mats, heel straps, and/or air ionizers for more protection.
- Always handle electrostatically sensitive components by their edge or by their casing.
- Avoid contact with pins, leads, or circuitry.
- Turn off power and input signals before inserting and removing connectors or connecting test equipment.
- Keep work area free of non-conductive materials such as ordinary plastic assembly aids and Styrofoam.
- Use field service tools such as cutters, screwdrivers, and vacuum cleaners that are conductive.

# Appendix B – Troubleshooting

Sealevel Software is supplied with the Sealevel Systems adapter and will be used in the troubleshooting procedures. By using this software and following these simple steps, most common problems can be eliminated without the need to call Technical Support.

1. Install software first. After installing the software then proceed to adding the hardware. This places the required installation files in the correct locations.
2. Read this manual thoroughly before attempting to install the adapter in your system.
3. Use Device Manager under Windows to verify proper installation. Refer to the Verifying Hardware section of this manual for instructions.
4. Several utilities with source code are included to verify the functionality of the outputs and to aid in application development. Consult the pin out diagrams to test at the card edge connector or at the end of the cable.
5. Use the VCTest to verify the basic I/O functionality of your digital I/O board. The source code is included to simplify application development in the programming language C.

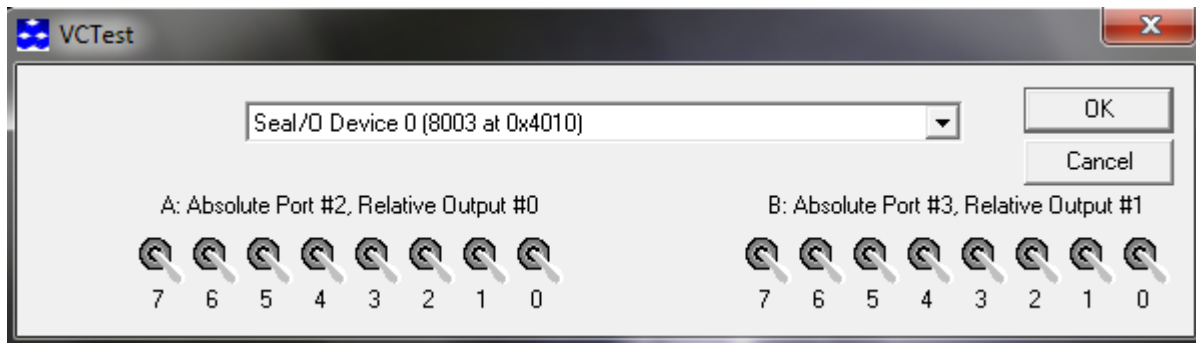

- VBTest is another utility included with Seal/O Classic software. The source code is included to aid with Visual Basic application development.

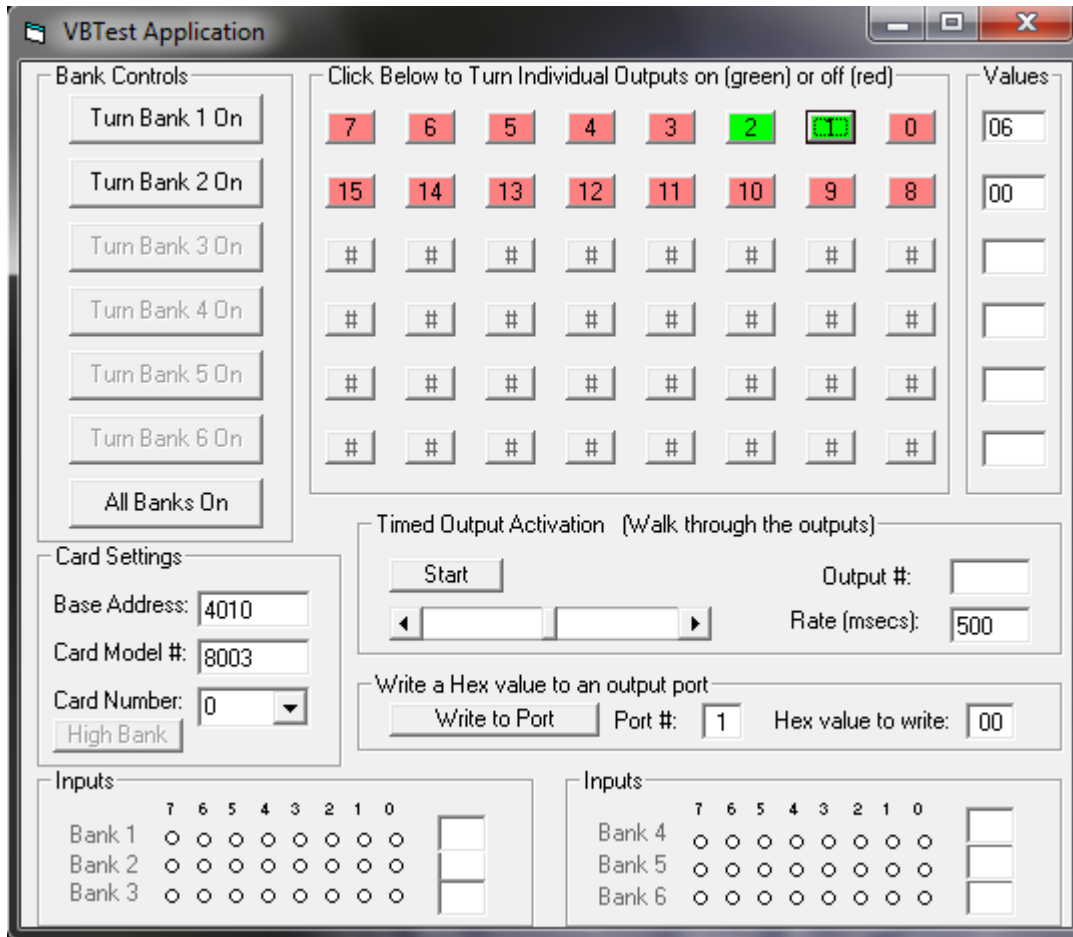

7. SealOTST is a command line utility that allows you to test the function calls from the Seal/O Classic API.

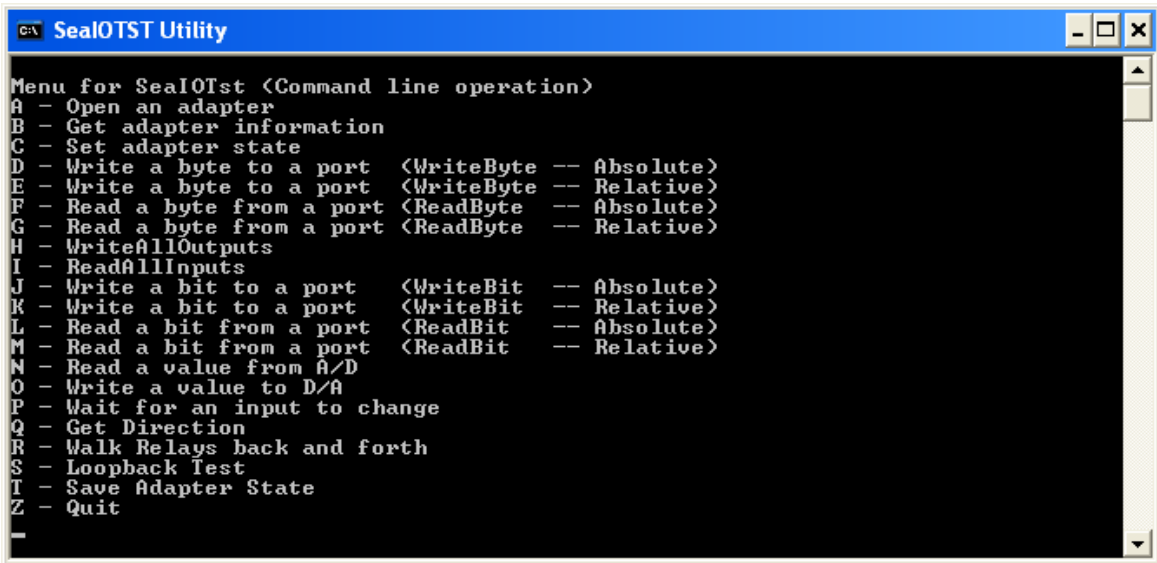

```
CA\ SealOTST Utility
Menu for SealOTst <Command line operation>
A - Open an adapter
B - Get adapter information
C - Set adapter state
D - Write a byte to a port <WriteByte -- Absolute>
E - Write a byte to a port <WriteByte -- Relative>
F - Read a byte from a port <ReadByte -- Absolute>
G - Read a byte from a port <ReadByte -- Relative>
H - WriteAllOutputs
I - ReadAllInputs
J - Write a bit to a port <WriteBit -- Absolute>
K - Write a bit to a port <WriteBit -- Relative>
L - Read a bit from a port <ReadBit -- Absolute>
M - Read a bit from a port <ReadBit -- Relative>
N - Read a value from A/D
O - Write a value to D/A
P - Wait for an input to change
Q - Get Direction
R - Walk Relays back and forth
S - Loopback Test
T - Save Adapter State
Z - Quit
```

**N** The source code for all utilities is located in the following folder: C:\Program Files\SealO\Samples

**N** The API is documented in the SealO help file. Start → All Programs → SealO → SealO Help. Launch the help file and expand the Programmers Interface section.

If these steps do not solve your problem, please call Sealevel Systems' Technical Support, (864) 843-4343. Our technical support is free and available from 8:00 AM-5:00 PM Eastern Time, Monday through Friday. For email support contact: [support@sealevel.com](mailto:support@sealevel.com).

# Appendix C – How To Get Assistance

Please refer to: [Appendix A](#) – Troubleshooting Guide prior to calling Technical Support.

Begin by reading through the Trouble Shooting Guide in Appendix A. If assistance is still needed, please see below.

When calling for technical assistance, please have your user manual and current adapter settings. If possible, please have the adapter installed in a computer ready to run diagnostics.

Sealevel Systems provides an FAQ section on its web site. Please refer to this to answer many common questions. This section can be found at <http://www.sealevel.com/faq.asp>.

Sealevel Systems maintains a web page on the Internet. Our home page address is [www.sealevel.com](http://www.sealevel.com). The latest software updates, and newest manuals are available via our web site.

Technical support is available Monday to Friday from 8:00 A.M. to 5:00 P.M. Eastern time. Technical support can be reached at (864) 843-4343.

**RETURN AUTHORIZATION MUST BE OBTAINED FROM SEALEVEL SYSTEMS BEFORE RETURNED MERCHANDISE WILL BE ACCEPTED. AUTHORIZATION CAN BE OBTAINED BY CALLING SEALEVEL SYSTEMS AND REQUESTING A RETURN MERCHANDISE AUTHORIZATION (RMA) NUMBER.**

# Appendix D – Drawing

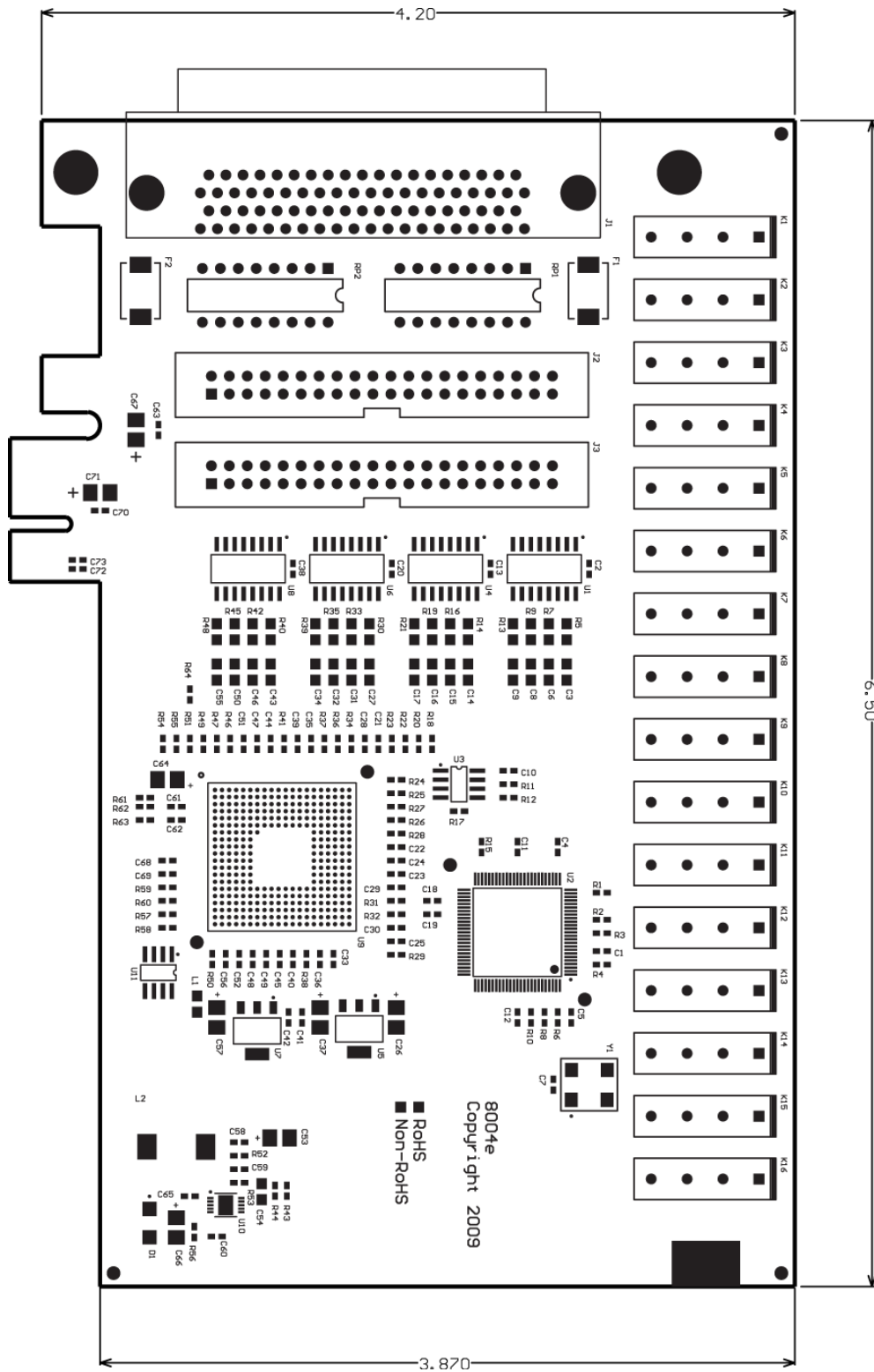

# Appendix E – Compliance Notices

## Federal Communications Commission (FCC) Statement



This equipment has been tested and found to comply with the limits for Class A digital device, pursuant to Part 15 of the FCC Rules. These limits are designed to provide reasonable protection against harmful interference when the equipment is operated in a commercial environment. This equipment generates, uses, and can radiate radio frequency energy and, if not installed and used in accordance with the instruction manual, may cause harmful interference to radio communications. Operation of this equipment in a residential area is likely to cause harmful interference in such case the user will be required to correct the interference at the user's expense.

## EMC Directive Statement



Products bearing the CE Label fulfill the requirements of the EMC directive (89/336/EEC) and of the low-voltage directive (73/23/EEC) issued by the European Commission. To obey these directives, the following European standards must be met:

- **EN55022 Class A** - "Limits and methods of measurement of radio interference characteristics of information technology equipment"
- **EN55024** – "Information technology equipment Immunity characteristics Limits and methods of measurement".



This is a Class A Product. In a domestic environment, this product may cause radio interference in which case the user may be required to take adequate measures to prevent or correct the interference.



Always use cabling provided with this product if possible. If no cable is provided or if an alternate cable is required, use high quality shielded cabling to maintain compliance with FCC/EMC directives.

# Warranty

Sealevel's commitment to providing the best I/O solutions is reflected in the Lifetime Warranty that is standard on all Sealevel manufactured I/O products. We are able to offer this warranty due to our control of manufacturing quality and the historically high reliability of our products in the field. Sealevel products are designed and manufactured at its Liberty, South Carolina facility, allowing direct control over product development, production, burn-in and testing. Sealevel achieved ISO-9001:2015 certification in 2018.

## Warranty Policy

Sealevel Systems, Inc. (hereafter "Sealevel") warrants that the Product shall conform to and perform in accordance with published technical specifications and shall be free of defects in materials and workmanship for the warranty period. In the event of failure, Sealevel will repair or replace the product at Sealevel's sole discretion. Failures resulting from misapplication or misuse of the Product, failure to adhere to any specifications or instructions, or failure resulting from neglect, abuse, accidents, or acts of nature are not covered under this warranty.

Warranty service may be obtained by delivering the Product to Sealevel and providing proof of purchase. Customer agrees to ensure the Product or assume the risk of loss or damage in transit, to prepay shipping charges to Sealevel, and to use the original shipping container or equivalent. Warranty is valid only for original purchaser and is not transferable.

This warranty applies to Sealevel manufactured Product. Product purchased through Sealevel but manufactured by a third party will retain the original manufacturer's warranty.

## Non-Warranty Repair/Retest

Products returned due to damage or misuse and Products retested with no problem found are subject to repair/retest charges. A purchase order or credit card number and authorization must be provided in order to obtain an RMA (Return Merchandise Authorization) number prior to returning Product.

## How to obtain an RMA (Return Merchandise Authorization)

If you need to return a product for warranty or non-warranty repair, you must first obtain an RMA number. Please contact Sealevel Systems, Inc. Technical Support for assistance:

Available	Monday – Friday, 8:00AM to 5:00PM EST
Phone	864-843-4343
Email	<a href="mailto:support@sealevel.com">support@sealevel.com</a>

## Trademarks

Sealevel Systems, Incorporated acknowledges that all trademarks referenced in this manual are the service mark, trademark, or registered trademark of the respective company.