

ULTRA COMM+I.LPCI

User Manual | 7108

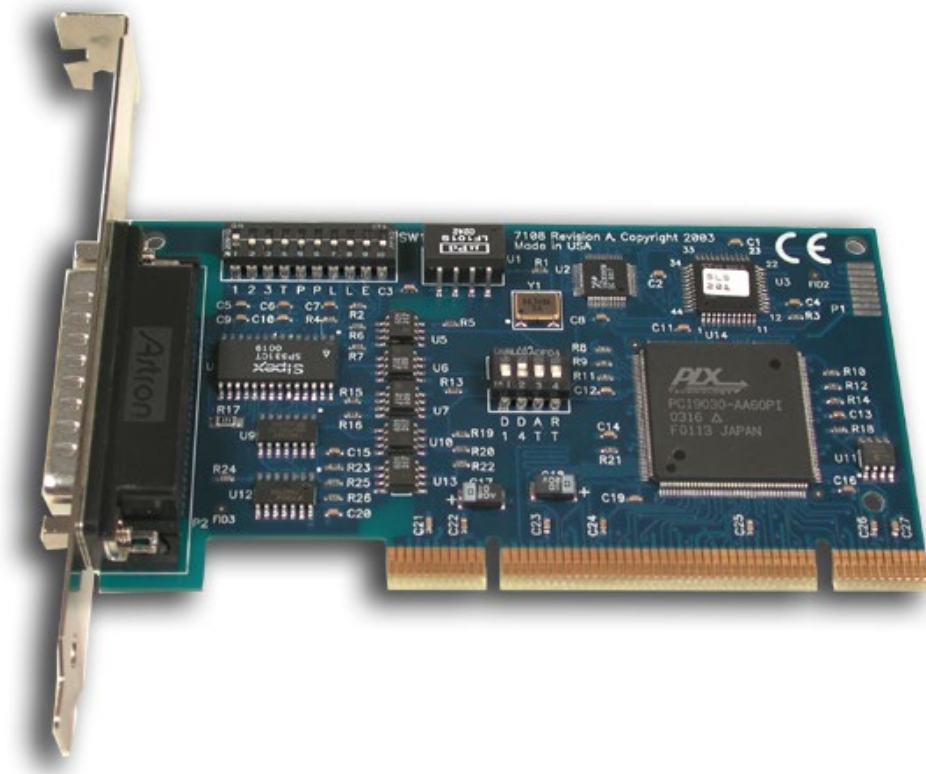

SEALEVEL®

Contents

- CONTENTS.....2
- INTRODUCTION3
- BEFORE YOU GET STARTED4
- CARD SETUP5
- INSTALLATION9
- PHYSICAL INSTALLATION11
- TECHNICAL DESCRIPTION12
- SPECIFICATIONS13
- APPENDIX A – TROUBLESHOOTING.....14
- APPENDIX B – HOW TO GET ASSISTANCE.....15
- APPENDIX C – ELECTRICAL INTERFACE16
- APPENDIX D - GROUND LOOP PHENOMENON17
- APPENDIX E – ASYNCHRONOUS COMMUNICATIONS18
- APPENDIX F – SILK SCREEN19
- APPENDIX G – COMPLIANCE NOTICES20
- WARRANTY21

Introduction

The Sealevel Systems **ULTRA COMM+I.LPCI** is a single channel isolated low profile Universal Bus serial I/O adapter for the PC and compatibles. Utilizing the Exar 16C850 UART with its industry leading 128 byte FIFOs, it provides a field selectable RS-232/422/485 serial port supporting data rates up to 921.6K bps (RS-422/485).

Configure as RS-232 for standard serial COM: port requirements. Choose the RS-422 mode for long distance device connections up to 5000ft. where noise immunity and high data integrity are essential. Select RS-485 and capture data from multiple peripherals in a RS-485 multidrop network. Up to 31 RS-485 devices can be connected to each port to automate your data collection. You can even mix the ports in any of the interface combinations to provide maximum flexibility to your application. *Optional Terminal Block adapters are available to simplify field-wiring connections.*

In both RS-232 and RS-422 modes, the card works seamlessly with the standard operating system serial driver. In RS-485 mode, our special auto-enable feature allows the RS-485 ports to be viewed by the operating system as a COM: port. This allows the standard COM: driver to be utilized for RS-485 communications. Our on-board hardware automatically handles the RS-485 driver enable.

The **ULTRA COMM+I.LPCI** ships with a Low Profile PCI bracket that will only work in a Low Profile PCI slot. If you need a standard size PCI bracket, please order Item# 7108S.

Before You Get Started

What's Included

The **ULTRA COMM+I.LPCI** is shipped with the following items. If any of these items is missing or damaged, contact the supplier.

- **ULTRA COMM+I.LPCI** Serial I/O Adapter
 - Item# 7108 ships with a Low Profile PCI bracket
 - Item# 7108S ships with a standard size PCI bracket

Advisory Conventions



Warning

The highest level of importance used to stress a condition where damage could result to the product, or the user could suffer serious injury.



Important

The middle level of importance used to highlight information that might not seem obvious or a situation that could cause the product to fail.



Note

The lowest level of importance used to provide background information, additional tips, or other non-critical facts that will not affect the use of the product.

Card Setup

Electrical Interface Selection

The **ULTRA COMM+I.LPCI** has the ability to be used as RS-232, RS-422 or RS-485. This is selectable via DIP-switch SW1. Please use the following examples to configure your adapter.

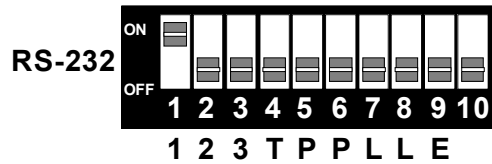

Figure 1- RS-232

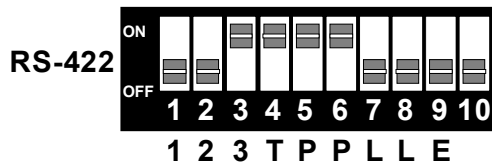

Figure 2 - RS-422

Figure 3 - RS-485, 4-Wire with Echo

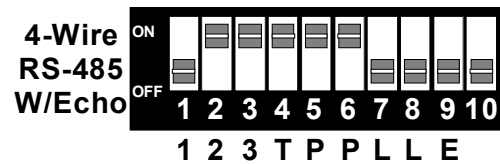

Figure 4 - RS-485 2-Wire with Echo

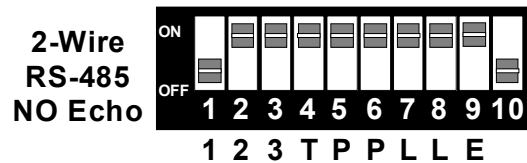
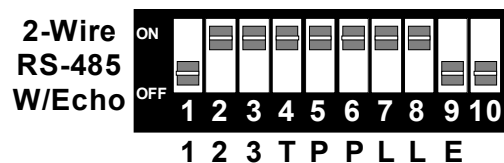

Figure 5 - RS-485, 2-wire without Echo

Line Termination

Typically, each end of the RS-485 bus must have line-terminating resistors (RS-422 terminates at the receive end only). A 120-ohm resistor is across each RS-422/485 input in addition to a 1K-ohm pull-up/pull-down combination that biases the receiver inputs. Switches SW1 and SW2 allow the user to customize this interface to their specific requirements. Each switch position corresponds to a specific portion of the interface. If multiple **ULTRA COMM+I.LPCI** adapters are configured in a RS-485 network, only the boards on each end should have jumpers T, P & P **ON**. Refer to the following table for each position's operation:

Name	Function
T	Adds or removes the 120 ohm termination.
P	Adds or removes the 1K ohm pull-down resistor in the RS-422/RS-485 receiver circuit (Receive data only).
P	Adds or removes the 1K ohm pull-up resistor in the RS-422/RS-485 receiver circuit (Receive data only).
L	Connects the TX+ to RX+ for RS-485 two wire operation.
L	Connects the TX- to RX- for RS-485 two wire operation.

RS-485 Enable Modes

RS-485 is ideal for multi-drop or network environments. RS-485 requires a tri-state driver that will allow the electrical presence of the driver to be removed from the line. The driver is in a tri-state or high impedance condition when this occurs. Only one driver may be active at a time and the other driver(s) must be tri-stated. The output modem control signal **Request To Send (RTS)** is typically used to control the state of the driver. Some communication software packages refer to RS-485 as RTS enable or RTS block mode transfer.

One of the unique features of the **ULTRA COMM+I.LPCI** is the ability to be RS-485 compatible without the need for special software or drivers. This ability is especially useful in Operating Systems where the lower level I/O control is abstracted from the application program. This ability means that the user can effectively use the **ULTRA COMM+I.LPCI** in an RS-485 application with existing (i.e. standard RS-232) software drivers.

Switch SW2 is used to control the RS-485 mode functions for the driver circuit. The selections are 'RTS' enable (silk-screen 'RT' switch position 4) or 'Auto' enable (silk-screen 'AT' switch position 3). The 'Auto' enable feature automatically enables/disables the RS-485 interface. The 'RTS' mode uses the 'RTS' modem control signal to enable the RS-485 interface and provides backward compatibility with existing software products.

The RS-485 'Echo' is the result of connecting the receiver inputs to the transmitter outputs. Every time a character is transmitted; it is also received. This can be beneficial if the software can handle echoing (i.e. using received characters to throttle the transmitter) or it can confuse the system if the software does not.

Position 9 of SW1 is used to control the RS-485 enable/disable functions for the receiver circuit. To select the 'No Echo' mode place switch position 9 to the 'On' position (see Figure 5).



Do not set both switches in the 'On' position. This could potentially cause damage to the adapter, and definitely cause a malfunction

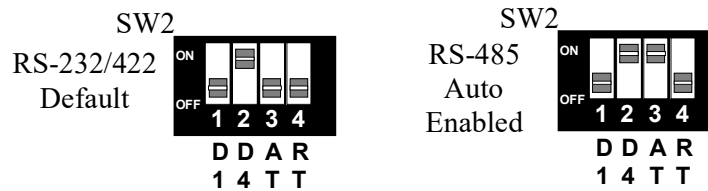

Figure 6 - RS-485 Enable modes

Clock Modes

The **ULTRA COMM+I.LPCI** employs a unique clocking option that allows the end user to select from divide by 4 and divide by 1 clocking modes. These modes are selected at switches SW-2.

To select the Baud rates commonly associated with COM: ports (i.e. 2400, 4800, 9600, 19.2, ... 115.2K Bps) set switch position 2 to the 'On' position (silk-screen D4). To select the maximum data rate (921.6K bps) set switch position 1 to the 'On' position (silk-screen D1).



Do not set both switches in the 'On' position. This could potentially cause damage to the adapter, and definitely cause a malfunction.

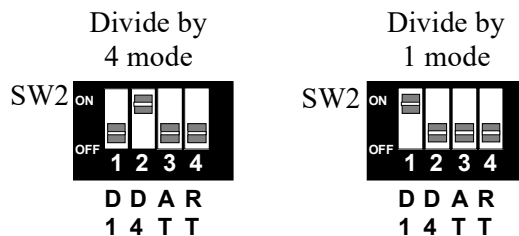

Figure 7 - Clocking Modes

Baud Rates and Divisors for the 'Div1' mode

The following table shows some common data rates and the rates you should choose to achieve them when using the **ULTRA COMM+I.LPCI** in the D1 mode. If the O/S of choice is Windows 95/98/ME/2000/NT/XP, the oscillator value (14.7456 MHz) should enter into the 'Advanced Tab' on 95/98/Me/2000/XP Device Manager applet. When using Windows NT, the 'Advanced Ports' applet in the Control Panel should be launched and the oscillator value may be entered in the 'Advanced' tab. When using any other OS (i.e. Linux, or QNX) the following tables should be used.

For this Data Rate	Choose this Data Rate
1200 bps	150 bps
2400 bps	300 bps
4800 bps	600 bps
9600 bps	1200 bps
19.2K bps	2400 bps
57.6 K bps	4800 bps
115.2 K bps	14.4K bps
230.4K bps	28.8K bps
460.8K bps	57.6 K bps
921.6K bps	115.2 K bps

If your communications package allows the use of Baud rate divisors, choose the appropriate divisor from the following table:

For this Data Rate	Choose this Divisor
1200 bps	768
2400 bps	384
4800 bps	192
9600 bps	96
19.2K bps	48
38.4K bps	24
57.6K bps	12
115.2K bps	8
230.4K bps	4
460.8K bps	2
921.6K bps	1

Installation

Software Installation

Windows Installation



Do not install the Adapter in the machine until the software has been fully installed.



Only users running Windows 7 or newer should utilize these instructions for accessing and installing the appropriate driver via Sealevel's website. If you are utilizing an operating system prior to Windows 7, please contact Sealevel by calling 864.843.4343 or emailing support@sealevel.com to receive access to the proper driver download and installation instructions.

1. Begin by locating, selecting, and installing the correct software from the [Sealevel software driver database](#).
2. Type in or select the part number (**#7108**) for the adapter from the listing.
3. Select "Download Now" for SeaCOM for Windows.
4. The setup files will automatically detect the operating environment and install the proper components. Follow the information presented on the screens that follow.
5. A screen may appear with text similar to: "The publisher cannot be determined due to the problems below: Authenticode signature not found." Please click the 'Yes' button and proceed with the installation. This declaration simply means that the operating system is not aware of the driver being loaded. It will not cause any harm to your system.
6. During setup, the user may specify installation directories and other preferred configurations. This program also adds entries to the system registry that are necessary for specifying the operating parameters for each driver. An uninstall option is also included to remove all registry/INI file entries from the system.
7. The software is now installed, and you can proceed with the hardware installation.

Linux Installation



You MUST have “root” privileges to install the software and drivers.



The syntax is case sensitive.

SeaCOM for Linux can be downloaded here: <https://www.sealevel.com/support/software-seacom-linux/>. It includes the **README** and the **Serial-HOWTO** help files (located at seacom/dox/howto). This series of files both explains typical Linux serial implementations and informs the user about Linux syntax and preferred practices.



User can use a program such as 7-Zip to extract the tar.gz file.

In addition, the software selectable interface settings can be accessed by referencing **seacom/utilities/7108mode**.

For additional software support, including QNX, please call Sealevel Systems’ Technical Support, (864) 843-4343. Our technical support is free and available from 8:00 AM - 5:00 PM Eastern Time, Monday through Friday. For email support contact: support@sealevel.com.

Physical Installation

The adapter can be installed in any PCI (5V or 3.3V) expansion slot.



Do not install the Adapter in the machine until the software has been fully installed.

1. **Turn off PC power. Disconnect the power cord.**
2. Remove the PC case cover.
3. Locate an available PCI slot and remove the blank metal slot cover.
4. Gently insert the PCI adapter into the slot. Make sure that the adapter is seated properly.
5. Replace the screw. (This is required to ensure FCC Part 15 compliance.)
6. Replace the cover.
7. Connect the power cord

Installation is finished.

Technical Description

The Sealevel Systems **ULTRA COMM+I.LPCI** provides a PCI interface adapter with an isolated asynchronous serial port providing a versatile interface, field selectable as RS-232 for modems, printers, and plotters, as well as RS-422/485 for industrial automation and control applications. Isolation is important in installations where the equipment being connected to the PC is either far from the PC, or on a different power transformer circuit. Ground loop current is a commonly neglected and misunderstood phenomenon that leads to data loss and the destruction of communications interfaces.

The **ULTRA COMM+I.LPCI** utilizes the 16C850 UART. This chip features programmable baud rates, data format, interrupt control and industry leading 128-byte FIFOs.

Connector Pin Assignments

RS-232 SIGNALS (DB-25 MALE)

Signal	Name	Pin #	Mode
GND	Ground	7	
RD	Receive Data	3	Input
CTS	Clear To Send	5	Input
TD	Transmit Data	2	Output
RTS	Request to Send	4	Output



Please terminate any control signals that are not going to be used. The most common way to do this is connect RTS to CTS. Terminating these pins, if not used, will help insure you get the best performance from your adapter.

RS-422/485/530 PIN ASSIGNMENTS (DB-25 MALE)

Signal		Name	Pin #	Mode
GND		Ground	7	
RDB	RX+	Receive Data Positive	16	Input
RDA	RX-	Receive Data Negative	3	Input
CTSB	CTS+	Clear To Send Positive	13	Input
CTSA	CTS-	Clear To Send Negative	5	Input
TDB	TX+	Transmit Data Positive	14	Output
TDA	TX-	Transmit Data Negative	2	Output
RTSB	RTS+	Request To Send Positive	19	Output
TRSA	RTS-	Request to Send Negative	4	Ouput

Specifications

Environmental Specifications

Specification	Operating	Storage
Temperature Range	0° to 70° C (32° to 158° F)	-50° to 105° C (-58° to 221° F)
Humidity Range	10 to 90% R.H. Non-Condensing	10 to 90% R.H. Non-Condensing

Manufacturing

All Sealevel Systems Printed Circuit boards are built to UL 94V0 rating and are 100% electrically tested. These printed circuit boards are solder mask over bare copper or solder mask over tin nickel.

Power Consumption

Supply line	+5 VDC
Rating	380 mA

Physical Dimensions

Board length	4.721 inches (11.991 cm)
Board height including Goldfingers	2.536 inches (6.441 cm)

Appendix A – Troubleshooting

Sealevel Software is supplied with the Sealevel Systems adapter and may be used in the troubleshooting procedures. Using this software and following these simple steps can eliminate most common problems without the need to call Technical Support.

1. Identify all I/O adapters currently installed in your system. This includes your on-board serial ports, controller cards, sound cards etc. The I/O addresses used by these adapters, as well as the IRQ (if any) should be identified.
2. Configure your Sealevel Systems adapter so that there is no conflict with currently installed adapters. No two adapters can occupy the same I/O address.
3. Make sure the Sealevel Systems adapter is using a unique IRQ. While the Sealevel Systems adapter does allow the sharing of IRQs, many other adapters (i.e., SCSI adapters & on-board serial ports) do not. The IRQ is typically selected by the BIOS or Operating system. Some BIOS setup software will allow changing the IRQ, but others do not. Another method of changing assigned resources is to try changing PCI slots. This will typically cause the BIOS or OS to reassign the resources.
4. Make sure the Sealevel Systems adapter is securely installed in a motherboard slot.
5. When running DOS or Windows 3.x refer to the Sealevel Software and this User Manual to verify that the Sealevel Systems adapter is configured correctly. This software contains a diagnostic program 'SSD' that will verify if an adapter is configured properly. This diagnostic program is written with the user in mind and is easy to use. Make sure that if available, the 'Use Plug-n-Play' option is turned '**OFF**' in your BIOS. Having this option set to '**ON**' in DOS or Windows 3.x will cause erratic operations.
6. WinSSD is available as a standalone utility and is included with Sealevel's SeaCOM, SeaLINK and SeaMAC software suites
7. Remember that a loopback test is not possible with the 'NE' switch turned on.
8. Always use the Sealevel Systems diagnostic software when troubleshooting a problem. This will eliminate any software issues from the equation.

Appendix B – How To Get Assistance

Please refer to Troubleshooting Guide prior to calling Technical Support.

1. Begin by reading through the Troubleshooting Guide in [Appendix A](#). If assistance is still needed, please see below.
2. When calling for technical assistance, please have your user manual and current adapter settings. If possible, please have the adapter installed in a computer ready to run diagnostics.
3. Sealevel Systems provides an FAQ section on its web site. Please refer to this to answer many common questions. This section can be found at <http://www.sealevel.com/faq.asp>.
4. Sealevel Systems maintains a web page on the Internet. Our home page address is www.sealevel.com. The latest software updates, and newest manuals are available via our web site.
5. Technical support is available Monday to Friday from 8:00 AM to 5:00 PM Eastern Time. Technical support can be reached at (864) 843-4343.

RETURN AUTHORIZATION MUST BE OBTAINED FROM SEALEVEL SYSTEMS BEFORE RETURNED MERCHANDISE WILL BE ACCEPTED. AUTHORIZATION CAN BE OBTAINED BY CALLING SEALEVEL SYSTEMS AND REQUESTING A RETURN MERCHANDISE AUTHORIZATION (RMA) NUMBER.

Appendix C – Electrical Interface

RS-232

Quite possibly the most widely used communication standard is RS-232. This implementation has been defined and revised several times and is often referred to as RS-232 or EIA/TIA-232. The IBM PC computer defined the RS-232 port on a 9 pin D sub connector and subsequently the EIA/TIA approved this implementation as the EIA/TIA-574 standard. This standard is defined as the *9-Position Non-Synchronous Interface between Data Terminal Equipment and Data Circuit-Terminating Equipment Employing Serial Binary Data Interchange*. Both implementations are in widespread use and will be referred to as RS-232 in this document. RS-232 is capable of operating at data rates up to 20 Kbps at distances less than 50 ft. The absolute maximum data rate may vary due to line conditions and cable lengths. RS-232 is a single ended or unbalanced interface, meaning that a single electrical signal is compared to a common signal (ground) to determine binary logic states. The RS-232 and the EIA/TIA-574 specification define two types of interface circuits, Data Terminal Equipment (DTE) and Data Circuit-Terminating Equipment (DCE). The COMM+850.LPCI is a DTE device.

RS-422

The RS-422 specification defines the electrical characteristics of balanced voltage digital interface circuits. RS-422 is a differential interface that defines voltage levels and driver/receiver electrical specifications. On a differential interface, logic levels are defined by the difference in voltage between a pair of outputs or inputs. In contrast, a single ended interface, for example RS-232, defines the logic levels as the difference in voltage between a single signal and a common ground connection. Differential interfaces are typically more immune to noise or voltage spikes that may occur on the communication lines. Differential interfaces also have greater drive capabilities that allow for longer cable lengths. RS-422 is rated up to 10 Megabits per second and can have cabling 4000 feet long. RS-422 also defines driver and receiver electrical characteristics that will allow 1 driver and up to 32 receivers on the line at once. RS-422 signal levels range from 0 to +5 volts. RS-422 does not define a physical connector.

RS-485

RS-485 is backwardly compatible with RS-422; however, it is optimized for party line or multi-drop applications. The output of the RS-422/485 driver is capable of being **Active** (enabled) or **Tri-State** (disabled). This capability allows multiple ports to be connected in a multi-drop bus and selectively polled. RS-485 allows cable lengths up to 4000 feet and data rates up to 10 Megabits per second. The signal levels for RS-485 are the same as those defined by RS-422. RS-485 has electrical characteristics that allow for 32 drivers and 32 receivers to be connected to one line. This interface is ideal for multi-drop or network environments. RS-485 tri-state driver (not dual-state) will allow the electrical presence of the driver to be removed from the line. Only one driver may be active at a time and the other driver(s) must be tri-stated. RS-485 can be cabled in two ways, two wire and four wire mode. Two-wire mode does not allow for full duplex communication and requires that data be transferred in only one direction at a time. For half-duplex operation, the two transmit pins should be connected to the two receive pins (Tx+ to Rx+ and Tx- to Rx-). Four wire mode allows full duplex data transfers. RS-485 does not define a connector pin-out or a set of modem control signals. RS-485 does not define a physical connector.

Appendix D - Ground Loop Phenomenon

What is Ground Loop?

Ground loop Phenomenon occurs when two (or more) pieces of equipment are connected together with a common ground and a different ground potential exists at each location. This current can cause the connected equipment to experience noise that in turn causes data transmission errors. In the extreme this ground current can cause equipment malfunction or even destruction.

Cabling Recommendations

When connecting the **ULTRA COMM+I.LPCI** in a RS-485 network, care should be taken that both ends of the network are not isolated from ground (see Figure 8). This “floating” ground condition could cause the capacitive or inductive coupling of voltages that will cause a break down in the DC to DC converter circuit or in the opto-isolator circuit. This condition will cause data errors and possibly destruction of the receiver circuit.

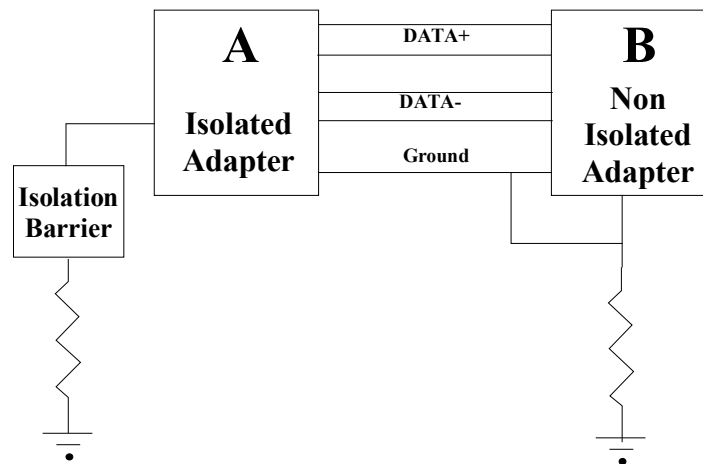

Figure 8 – **ULTRA COMM+I.LPCI** cabling example

Appendix E – Asynchronous Communications

Serial data communications implies that individual bits of a character are transmitted consecutively to a receiver that assembles the bits back into a character. Data rate, error checking, handshaking, and character framing (start/stop bits) are pre-defined and must correspond at both the transmitting and receiving ends.

Asynchronous communications is the standard means of serial data communication for PC compatibles and PS/2 computers. The original PC was equipped with a communication or COM: port that was designed around an 8250 Universal Asynchronous Receiver Transmitter (UART). This device allows asynchronous serial data to be transferred through a simple and straightforward programming interface. A start bit, followed by a pre-defined number of data bits (5, 6, 7, or 8) defines character boundaries for asynchronous communications. The end of the character is defined by the transmission of a pre-defined number of stop bits (usually 1, 1.5 or 2). An extra bit used for error detection is often appended before the stop bits.

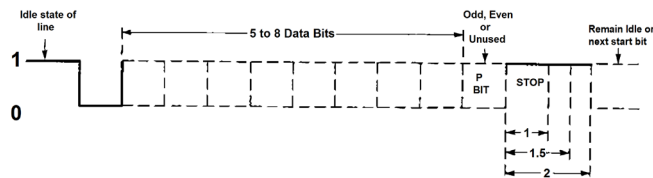
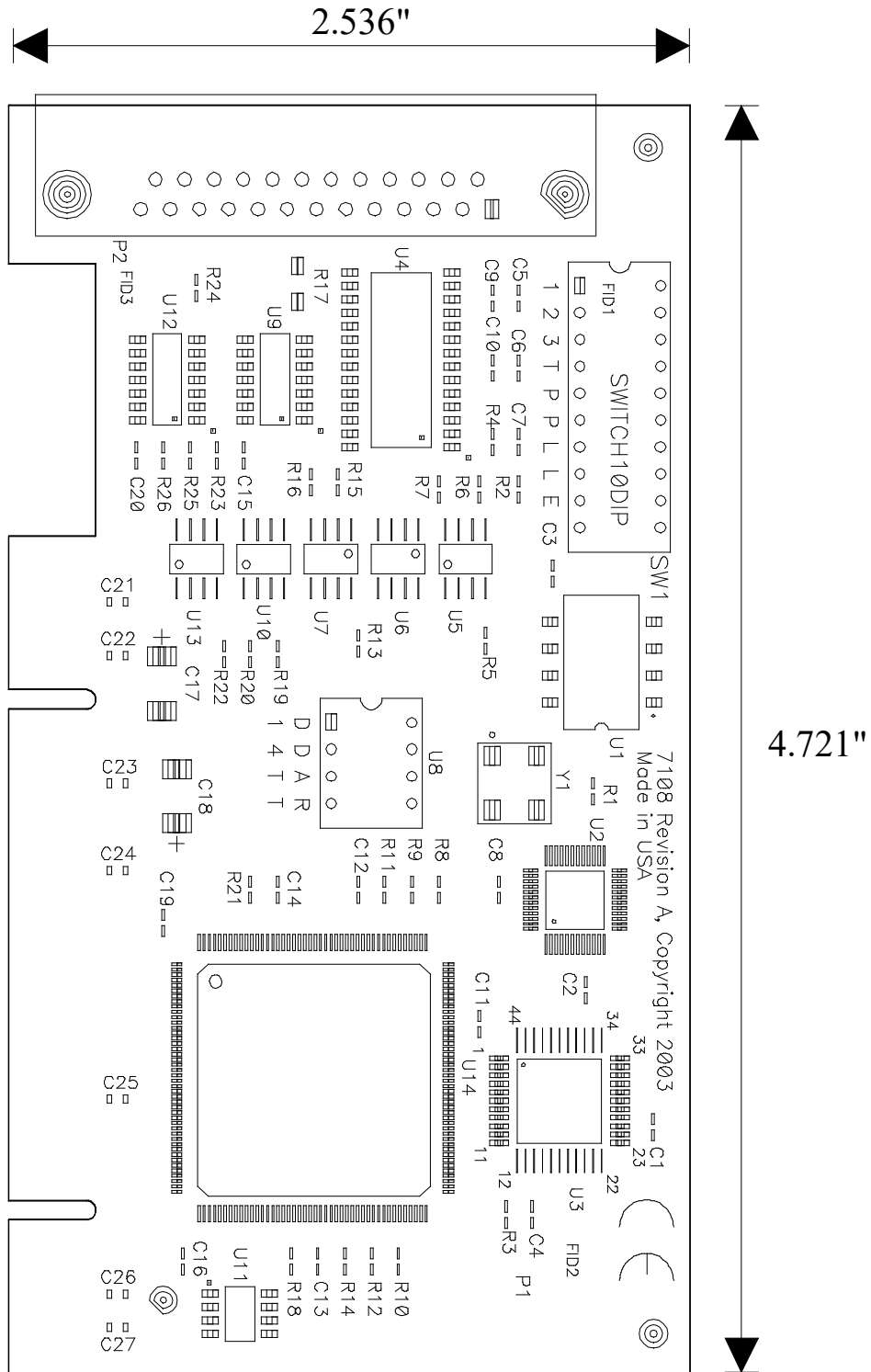

Figure 9 - Asynchronous Communications Bit Diagram

This special bit is called the parity bit. Parity is a simple method of determining if a data bit has been lost or corrupted during transmission. There are several methods for implementing a parity check to guard against data corruption. Common methods are called (E)ven Parity or (O)dd Parity. Sometimes parity is not used to detect errors on the data stream. This is referred to as (N)o parity. Because each bit in asynchronous communications is sent consecutively, it is easy to generalize asynchronous communications by stating that each character is wrapped (framed) by pre-defined bits to mark the beginning and end of the serial transmission of the character. The data rate and communication parameters for asynchronous communications have to be the same at both the transmitting and receiving ends. The communication parameters are baud rate, parity, number of data bits per character, and stop bits (i.e., 9600,N,8,1).

Appendix F – Silk Screen



Appendix G – Compliance Notices

Federal Communications Commission (FCC) Statement



This equipment has been tested and found to comply with the limits for Class A digital device, pursuant to Part 15 of the FCC Rules. These limits are designed to provide reasonable protection against harmful interference when the equipment is operated in a commercial environment. This equipment generates, uses, and can radiate radio frequency energy and, if not installed and used in accordance with the instruction manual, may cause harmful interference to radio communications. Operation of this equipment in a residential area is likely to cause harmful interference in such case the user will be required to correct the interference at the user's expense.

EMC Directive Statement



Products bearing the CE Label fulfill the requirements of the EMC directive (89/336/EEC) and of the low-voltage directive (73/23/EEC) issued by the European Commission. To obey these directives, the following European standards must be met:

- **EN55022 Class A** - "Limits and methods of measurement of radio interference characteristics of information technology equipment"
- **EN55024** – "Information technology equipment Immunity characteristics Limits and methods of measurement".



This is a Class A Product. In a domestic environment, this product may cause radio interference in which case the user may be required to take adequate measures to prevent or correct the interference.



Always use cabling provided with this product if possible. If no cable is provided or if an alternate cable is required, use high quality shielded cabling to maintain compliance with FCC/EMC directives.

Warranty

Sealevel's commitment to providing the best I/O solutions is reflected in the Lifetime Warranty that is standard on all Sealevel manufactured I/O products. We are able to offer this warranty due to our control of manufacturing quality and the historically high reliability of our products in the field. Sealevel products are designed and manufactured at its Liberty, South Carolina facility, allowing direct control over product development, production, burn-in and testing. Sealevel achieved ISO-9001:2015 certification in 2018.

Warranty Policy

Sealevel Systems, Inc. (hereafter "Sealevel") warrants that the Product shall conform to and perform in accordance with published technical specifications and shall be free of defects in materials and workmanship for the warranty period. In the event of failure, Sealevel will repair or replace the product at Sealevel's sole discretion. Failures resulting from misapplication or misuse of the Product, failure to adhere to any specifications or instructions, or failure resulting from neglect, abuse, accidents, or acts of nature are not covered under this warranty.

Warranty service may be obtained by delivering the Product to Sealevel and providing proof of purchase. Customer agrees to ensure the Product or assume the risk of loss or damage in transit, to prepay shipping charges to Sealevel, and to use the original shipping container or equivalent. Warranty is valid only for original purchaser and is not transferable.

This warranty applies to Sealevel manufactured Product. Product purchased through Sealevel but manufactured by a third party will retain the original manufacturer's warranty.

Non-Warranty Repair/Retest

Products returned due to damage or misuse and Products retested with no problem found are subject to repair/retest charges. A purchase order or credit card number and authorization must be provided in order to obtain an RMA (Return Merchandise Authorization) number prior to returning Product.

How to obtain an RMA (Return Merchandise Authorization)

If you need to return a product for warranty or non-warranty repair, you must first obtain an RMA number. Please contact Sealevel Systems, Inc. Technical Support for assistance:

Available	Monday – Friday, 8:00 AM to 5:00 PM EST
Phone	864-843-4343
Email	support@sealevel.com

Trademarks

Sealevel Systems, Incorporated acknowledges that all trademarks referenced in this manual are the service mark, trademark, or registered trademark of the respective company.