

SEALINK+485I

User Manual | 2104



SEALEVEL®

Contents

- CONTENTS..... 2
- INTRODUCTION 3
- BEFORE YOU GET STARTED 4
- INSTALLATION 5
- HARDWARE INSTALLATION 7
- CONFIGURATION..... 9
- TECHNICAL DESCRIPTION 11
- SPECIFICATIONS..... 12
- APPENDIX A – TROUBLESHOOTING..... 13
- APPENDIX B – HOW TO GET ASSISTANCE 14
- APPENDIX C – ELECTRICAL INTERFACE 15
- APPENDIX D – GROUND LOOP PHENOMENON..... 16
- APPENDIX E – ASYNCHRONOUS COMMUNICATIONS 17
- APPENDIX F – SILK-SCREEN 18
- APPENDIX G – COMPLIANCE NOTICES 19
- WARRANTY..... 20

Introduction

Overview

The Sealevel Systems **SeaLINK+485I** equips the PC with 1 isolated USB to RS-422/485 Asynchronous serial port providing a versatile interface for common RS-422/485 needs. The **SeaLINK+485I** connects through the PC's external USB port, so it does not require opening the computer case. Resources such as IRQ's and I/O addresses are also not utilized. It does require a system that supports USB in hardware and operating system.

Before You Get Started

What's Included

The **SeaLINK+485I** is shipped with the following items. If any of these items is missing or damaged, contact the supplier.

- **SeaLINK+485I** Isolated USB to RS-422/485 Serial I/O Adapter
- USB Cable Part Number CA179 for Connecting to Upstream Host/Hub

Advisory Conventions



Warning

The highest level of importance used to stress a condition where damage could result to the product, or the user could suffer serious injury.



Important

The middle level of importance used to highlight information that might not seem obvious or a situation that could cause the product to fail.



Note

The lowest level of importance used to provide background information, additional tips, or other non-critical facts that will not affect the use of the product.

Installation

Operating System Installation

Windows Installation



Do not install the Adapter in the machine until the software has been fully installed.



Only users running Windows 7 or newer should utilize these instructions for accessing and installing the appropriate driver via Sealevel's website. If you are utilizing an operating system prior to Windows 7, please contact Sealevel by calling 864.843.4343 or emailing support@sealevel.com to receive access to the proper driver download and installation instructions.

1. Begin by locating, selecting, and installing the correct software from the [Sealevel software driver database](#).
2. Type in or select the part number (#2104) for the adapter from the listing.
3. Select "Download Now" for SeaCOM for Windows.
4. SeaCOM software can also be downloaded from the 2104-product webpage: [SeaLINK+485I Product](#)
5. The setup files will automatically detect the operating environment and install the proper components. Follow the information presented on the screens that follow.
6. A screen may appear with text similar to: "The publisher cannot be determined due to the problems below: Authenticode signature not found." Please click the 'Yes' button and proceed with the installation. This declaration simply means that the operating system is not aware of the driver being loaded. It will not cause any harm to your system.
7. During setup, the user may specify installation directories and other preferred configurations. This program also adds entries to the system registry that are necessary for specifying the operating parameters for each driver. An uninstall option is also included to remove all registry/INI file entries from the system.
8. The software is now installed, and you can proceed with the hardware installation.

Linux Installation



You MUST have “root” privileges to install the software and drivers.



The syntax is case sensitive.

SeaCOM for Linux can be downloaded here: <https://www.sealevel.com/support/software-seacom-linux/>. It includes the **README** and the **Serial-HOWTO** help files (located at seacom/dox/howto). This series of files both explains typical Linux serial implementations and informs the user about Linux syntax and preferred practices.



User can use a program such as 7-Zip to extract the tar.gz file.

In addition, the software selectable interface settings can be accessed by referencing **seacom/utilities/2104mode**.

For additional software support, including QNX, please call Sealevel Systems' Technical Support, (864) 843-4343. Our technical support is free and available from 8:00 AM - 5:00 PM Eastern Time, Monday through Friday. For email support contact: support@sealevel.com.

You are now ready to proceed with connecting the 2104 to your system. Refer to the Hardware Installation section for details.



Windows NT is not USB aware and thus cannot support this device.

Hardware Installation

The screen captures below are taken from a Windows 7 installation. Your particular operating system may differ slightly from what is shown based on your version of windows.

The **SeaLINK+485I** can be connected to any Upstream Type “A” port either at the PC host or an Upstream Hub. The **SeaLINK+485I** is hot-pluggable, meaning there is no need to power down your computer prior to installation. The **SeaLINK+485I** has an onboard 8 position dip switch that is used to configure the interface. Prior to connecting the **SeaLINK+485I**, be sure to configure this dip switch for your specific application. Please see the Configuration section for more information. The **SeaLINK+485I** is defaulted to RS-422 mode so changes are only required if you will be using the product in an RS-485 application.

1. After installing the software connect **SeaLINK+485I** to an Upstream Host or Hub.

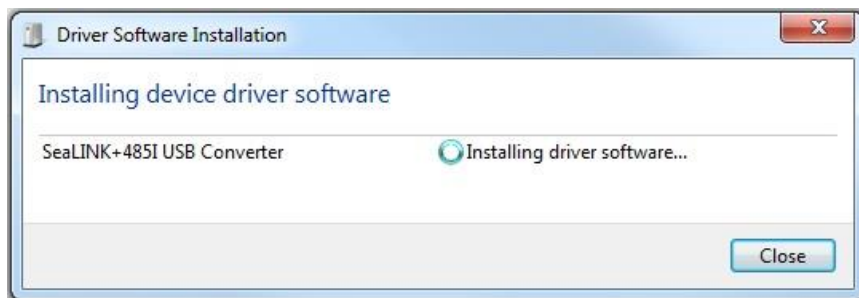

This indicates that the system has recognized the new device and will now proceed to locate and automatically install the driver.

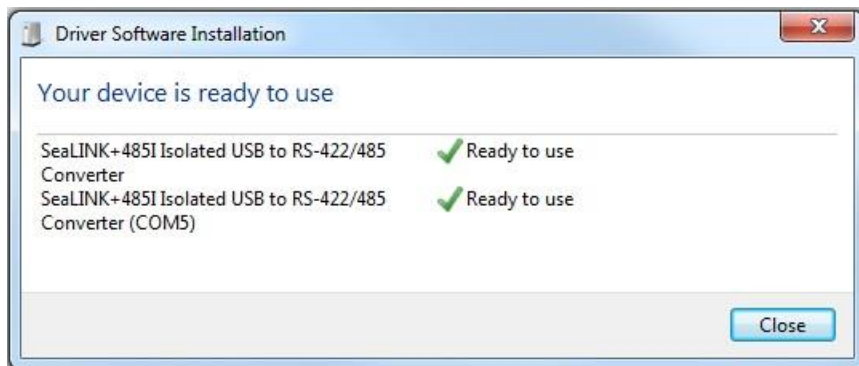

This window indicates that the device has been successfully installed. You may see these windows appear as a balloon in the bottom right corner of your desktop momentarily instead of as a window. If you view your system’s Device Manager at this point, you should have a new “COM” port in the Ports (COM & LPT) Device Class. It should look similar to the screen shot on the following page.

HARDWARE INSTALLATION, CONTINUED



You can access your new COM: port by using the assigned COM: identifier shown above. In this case, it is COM5: but this assignment will vary from system to system. At this point, the hardware is recognized. To verify operation, use Sealevel Systems supplied WinSSD diagnostic utility. WinSSD can be found in the Start Menu under the SeaCOM group.

Configuration

Electrical Interface Selection

The port on the **SeaLINK+485I** has the ability to be used in both half and full duplex RS-422/485 applications. This is selectable through DIP-switch SW1. The chart below describes each of the switch position's function. Please refer to the following page for switch setting examples. Switch SW1, in the "ON" position, either enables, adds, or connects, based on the function of the switch position listed below. Switch SW1, position OFF, disables, removes, or disconnects .

SW1	Function
1	RS-485 Two Wire Auto Enable/Disable
2	Echo Enable/Disable
3	Adds or removes the 120-ohm termination
4	Adds or removes the 1K ohm pull-up resistor in the RS-422/RS-485 receiver circuit (Receive data only)
5	Adds or removes the 1K ohm pull-down resistor in the RS-422/RS-485 receiver circuit (Receive data only)
6	Connects the TX+ to RX+ for RS-485 two wire operation
7	Connects the TX- to RX- for RS-485 two wire operation
8	Not Used

CONFIGURATION, CONTINUED

Switch Examples

Please use the following examples to configure your adapter.

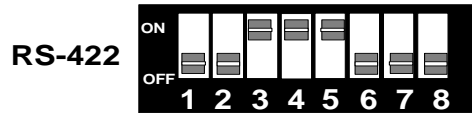

Figure 1 - RS-422, 4 Wire RS-485 (Default)

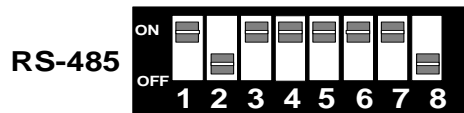

Figure 2 - RS-485, 2 Wire with Echo

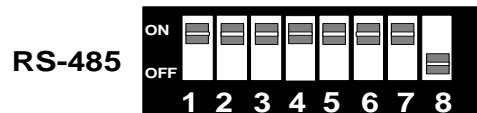

Figure 3 - TD-485, 2 Wire No Echo



Figure 2 is the first RS-485 picture: 1 ON, 2 off, 3 ON, 4 ON, 5 ON, 6 ON, 7 ON, 8 off.



Figure 3 is the second RS-485 picture: 1 ON, 2 ON, 3 ON, 4 ON, 5 ON, 6 ON, 7 ON, 8 off.

Technical Description

The **SeaLINK+485I**: utilizes a USB UART. This chip features programmable baud rate, data format, 128-byte Dual Port RX Buffer, and 256-byte Dual Port TX Buffer. The RS-422/485 transceiver supports data rates from 300 baud up to 921.6K baud.

Features

- Hot-Pluggable device
- Does not require opening the case
- No system resources are required (i.e., I/O ports or IRQ's)
- LED status indicators for "USB Enabled", "TD", and "RD"

Connector Pin Assignments (DB25 Male)

The **SeaLINK+485I** complies with the EIA-530 pin out with the following signals supported

Signal		Name	Pin #	Mode
GND		Ground	7	
RDB	RX+	Receive Positive	16	Input
RDA	RX-	Receive Negative	3	Input
TDB	TX+	Transmit Positive	14	Output
TDA	TX-	Transmit Negative	2	Output



The modem control signals are internally biased as follows: RTS is connected to CTS, DTR is connected to DCD and DSR, and RI is tied inactive.

Specifications

Environmental Specifications

Specification	Operating	Storage
Temperature Range	0° to 50° C (32° to 122° F)	-20° to 70° C (-4° to 158° F)
Humidity Range	10 to 90% R.H. Non-Condensing	10 to 90% R.H. Non-Condensing

Manufacturing

All Sealevel Systems Printed Circuit boards are built to UL 94V0 rating and are 100% electrically tested. These printed circuit boards are solder mask over bare copper or solder mask over tin nickel.

Power Consumption

Supply line	+5 VDC
Rating	100 mA

Mean Time Between Failures (MTBF)

Greater than 150,000 hours. (Calculated)

Physical Dimensions

Package Length	3.8 inches (9.66 cm)
Package Width	2.3 inches (5.84 cm)
Package Height	1.0 inches (2.54 cm)

Appendix A – Troubleshooting

The adapter should provide years of trouble-free service. However, in the event that device appears to not be functioning incorrectly, the following tips can eliminate most common problems without the need to call Technical Support.

1. If your adapter isn't working, first check to make sure that USB support is enabled in the System BIOS and it is functioning properly in the operating system. This can be done by using either the Windows 98/ME or Windows 2000 Device Manager.
2. Ensure that the Sealevel Systems software has been installed on the machine so that the necessary files are in place to complete the installation.
3. When the **SeaLINK+485I** is configured properly, the USB Enabled LED (EN) will be lit. This should allow you to use Sealevel's WinSSD utility and the supplied loopback plug to check communications. The supplied loopback plug connects TD to RD. If you decide to test the Modem Control Signals, a full pin loopback plug will be required. Details on loopback plugs are included within WinSSD. Contact Sealevel Systems if you need further assistance.
4. When testing the **SeaLINK+485I** in loopback mode, you should see both the TD and RD LED's flashing as well as seeing echoed data on the screen. The loopback test first transmits a HEX pattern, 55AA, and then an ASCII string of data. If this test passes, then the **SeaLINK+485I** is ready for use in your application.
5. Please note that if the card is configured for 2 wire RS-485 with no echo a loopback test is not possible. The receiver in this case will be turned off and the test will fail. If you plan on using this device in two wire mode test the adapter in RS-422 mode first. Then configure the adapter for your application.

If these steps do not solve your problem, please call Sealevel Systems' Technical Support, (864) 843-4343. Our technical support is free and available from 8:00 A.M.- 5:00 P.M. Eastern Time Monday through Friday. For email support contact support@sealevel.com.

Appendix B – How To Get Assistance

Please refer to Troubleshooting Guide prior to calling Technical Support.

1. Begin by reading through the Trouble Shooting Guide in Appendix A. If assistance is still needed, please see below.
2. When calling for technical assistance, please have your user manual and current adapter settings. If possible, please have the adapter installed in a computer ready to run diagnostics.
3. Sealevel Systems provides an FAQ section on its web site. Please refer to this to answer many common questions. This section can be found at <http://www.sealevel.com/faq.asp>.
4. Sealevel Systems maintains a web page on the Internet. Our home page address is www.sealevel.com. The latest software updates, and newest manuals are available via our web site.
5. Technical support is available Monday to Friday from 8:00 A.M. to 5:00 P.M. Eastern Time. Technical support can be reached at (864) 843-4343.

RETURN AUTHORIZATION MUST BE OBTAINED FROM SEALEVEL SYSTEMS BEFORE RETURNED MERCHANDISE WILL BE ACCEPTED. AUTHORIZATION CAN BE OBTAINED BY CALLING SEALEVEL SYSTEMS AND REQUESTING A RETURN MERCHANDISE AUTHORIZATION (RMA) NUMBER.

Appendix C – Electrical Interface

RS-422

The RS-422 specification defines the electrical characteristics of balanced voltage digital interface circuits. RS-422 is a differential interface that defines voltage levels and driver/receiver electrical specifications. On a differential interface, logic levels are defined by the difference in voltage between a pair of outputs or inputs. In contrast, a single ended interface, for example RS-232, defines the logic levels as the difference in voltage between a single signal and a common ground connection. Differential interfaces are typically more immune to noise or voltage spikes that may occur on the communication lines. Differential interfaces also have greater drive capabilities that allow for longer cable lengths. RS-422 is rated up to 10 Megabits per second and can have cabling 4000 feet long. RS-422 also defines driver and receiver electrical characteristics that will allow 1 driver and up to 32 receivers on the line at once. RS-422 signal levels range from 0 to +5 volts. RS-422 does not define a physical connector.

RS-485

RS-485 is backwardly compatible with RS-422; however, it is optimized for party line or multi-drop applications. The output of the RS-422/485 driver is capable of being **Active** (enabled) or **Tri-State** (disabled). This capability allows multiple ports to be connected in a multi-drop bus and selectively polled. RS-485 allows cable lengths up to 4000 feet and data rates up to 10 Megabits per second. The signal levels for RS-485 are the same as those defined by RS-422. RS-485 has electrical characteristics that allow for 32 drivers and 32 receivers to be connected to one line. This interface is ideal for multi-drop or network environments. RS-485 tri-state driver (not dual-state) will allow the electrical presence of the driver to be removed from the line. Only one driver may be active at a time and the other driver(s) must be tri-stated. RS-485 can be cabled in two ways, two wire and four wire mode. Two wire mode does not allow for full duplex communication and requires that data be transferred in only one direction at a time. For half-duplex operation, the two transmit pins should be connected to the two receive pins (Tx+ to Rx+ and Tx- to Rx-). Four wire mode allows full duplex data transfers. RS-485 does not define a connector pin-out or a set of modem control signals. RS-485 does not define a physical connector.

Appendix D – Ground Loop Phenomenon

What is Ground Loop?

Ground loop Phenomenon occurs when two (or more) pieces of equipment are connected with a common ground and a different ground potential exists at each location. This current can cause the connected equipment to experience noise that in turn causes data transmission errors. In the extreme this ground current can cause equipment malfunction or even destruction.

Cabling Recommendations

When connecting the **SeaLINK+485I** in an RS-485 network, care should be taken that both ends of the network are not isolated from ground (see Figure 4). This “floating” ground condition could cause capacitive or inductive coupling of voltages that will cause a break down in the DC to DC converter circuit or in the opto-isolator circuit. This condition will cause data errors and possibly destruction of the receiver circuit.

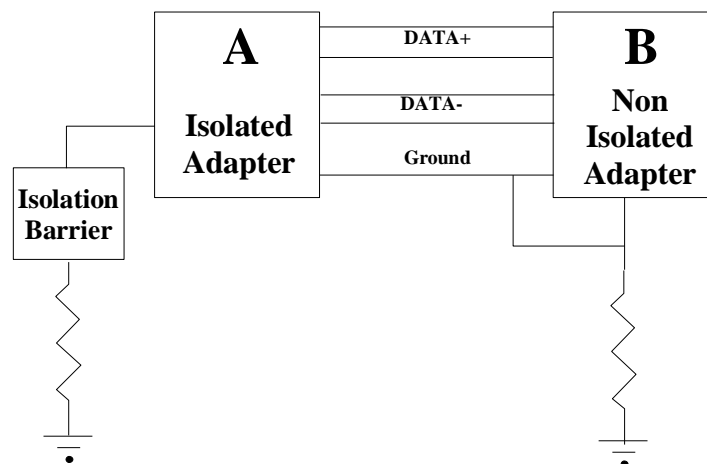
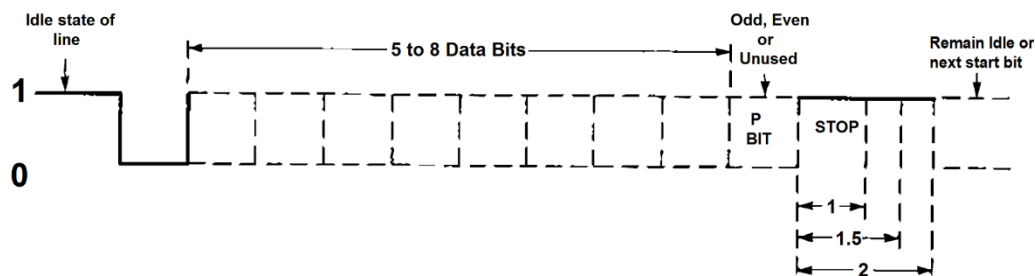

Figure 4 - SeaLINK+485I cabling sample

Appendix E – Asynchronous Communications

Serial data communications implies that individual bits of a character are transmitted consecutively to a receiver that assembles the bits back into a character. Data rate, error checking, handshaking, and character framing (start/stop bits) are pre-defined and must correspond at both the transmitting and receiving ends.

Asynchronous communications is the standard means of serial data communication for PC compatibles and PS/2 computers. The original PC was equipped with a communication or COM: port that was designed around an 8250 Universal Asynchronous Receiver Transmitter (UART). This device allows asynchronous serial data to be transferred through a simple and straightforward programming interface. A start bit, followed by a pre-defined number of data bits (5, 6, 7, or 8) defines character boundaries for asynchronous communications. The end of the character is defined by the transmission of a pre-defined number of stop bits (usually 1, 1.5 or 2). An extra bit used for error detection is often appended before the stop bits.



Asynchronous Communications Bit Diagram

This special bit is called the parity bit. Parity is a simple method of determining if a data bit has been lost or corrupted during transmission. There are several methods for implementing a parity check to guard against data corruption. Common methods are called (E)ven Parity or (O)dd Parity. Sometimes parity is not used to detect errors on the data stream. This is referred to as (N)o parity. Because each bit in asynchronous communications is sent consecutively, it is easy to generalize asynchronous communications by stating that each character is wrapped (framed) by pre-defined bits to mark the beginning and end of the serial transmission of the character. The data rate and communication parameters for asynchronous communications must be the same at both the transmitting and receiving ends. The communication parameters are baud rate, parity, number of data bits per character, and stop bits (i.e., 9600, N, 8, 1).

Appendix F – Silk-Screen

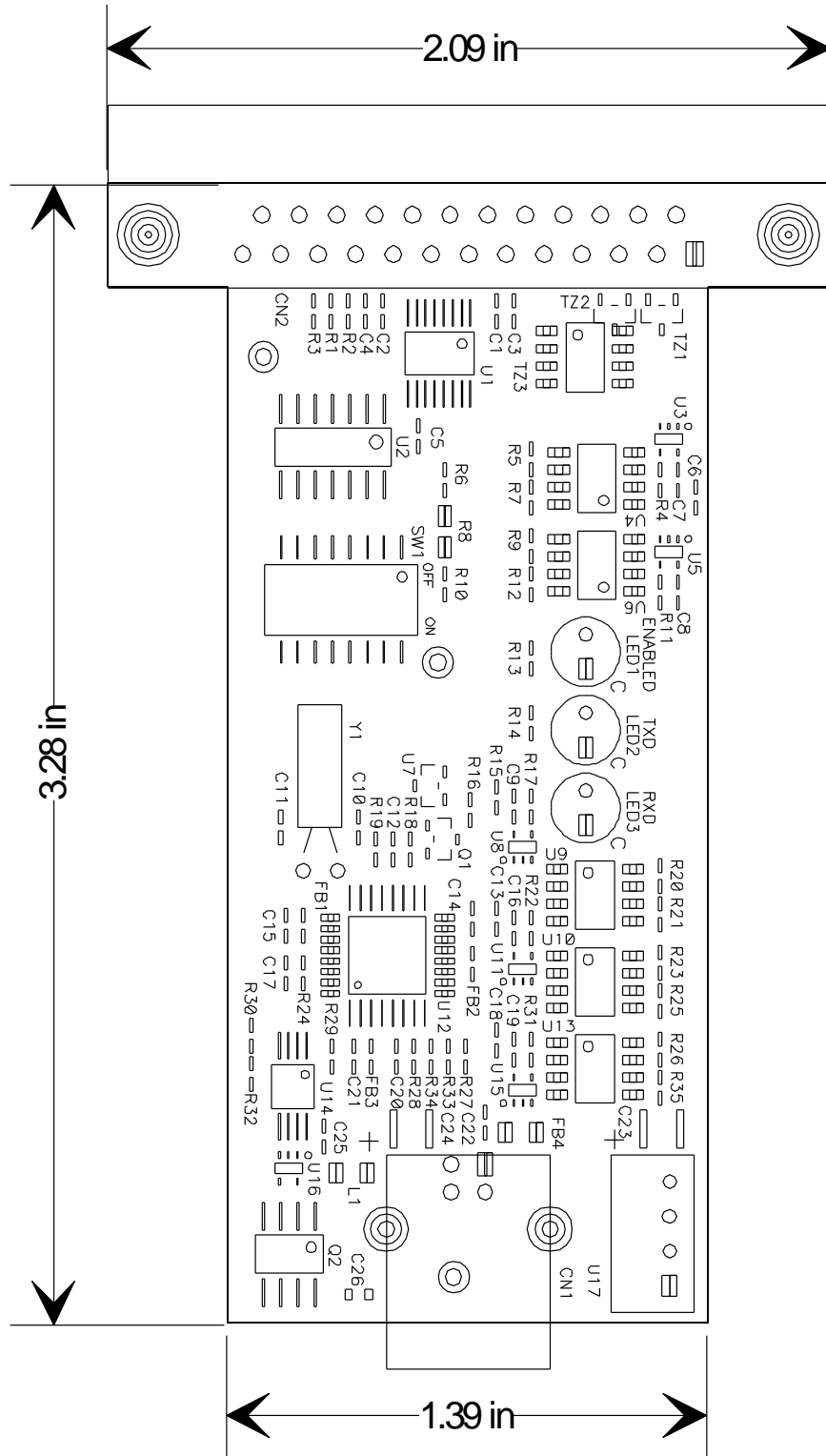

Appendix G – Compliance Notices

Federal Communications Commission (FCC) Statement



This equipment has been tested and found to comply with the limits for Class A digital device, pursuant to Part 15 of the FCC Rules. These limits are designed to provide reasonable protection against harmful interference when the equipment is operated in a commercial environment. This equipment generates, uses, and can radiate radio frequency energy and, if not installed and used in accordance with the instruction manual, may cause harmful interference to radio communications. Operation of this equipment in a residential area is likely to cause harmful interference in such case the user will be required to correct the interference at the user's expense.



This is a Class B Product. In a domestic environment, this product may cause radio interference in which case the user may be required to take adequate measures to prevent or correct the interference.



Always use cabling provided with this product if possible. If no cable is provided or if an alternate cable is required, use high quality shielded cabling to maintain compliance with FCC/EMC directives.

Warranty

Sealevel's commitment to providing the best I/O solutions is reflected in the Lifetime Warranty that is standard on all Sealevel manufactured I/O products. We are able to offer this warranty due to our control of manufacturing quality and the historically high reliability of our products in the field. Sealevel products are designed and manufactured at its Liberty, South Carolina facility, allowing direct control over product development, production, burn-in and testing. Sealevel achieved ISO-9001:2015 certification in 2018.

Warranty Policy

Sealevel Systems, Inc. (hereafter "Sealevel") warrants that the Product shall conform to and perform in accordance with published technical specifications and shall be free of defects in materials and workmanship for the warranty period. In the event of failure, Sealevel will repair or replace the product at Sealevel's sole discretion. Failures resulting from misapplication or misuse of the Product, failure to adhere to any specifications or instructions, or failure resulting from neglect, abuse, accidents, or acts of nature are not covered under this warranty.

Warranty service may be obtained by delivering the Product to Sealevel and providing proof of purchase. Customer agrees to ensure the Product or assume the risk of loss or damage in transit, to prepay shipping charges to Sealevel, and to use the original shipping container or equivalent. Warranty is valid only for original purchaser and is not transferable.

This warranty applies to Sealevel manufactured Product. Product purchased through Sealevel but manufactured by a third party will retain the original manufacturer's warranty.

Non-Warranty Repair/Retest

Products returned due to damage or misuse and Products retested with no problem found are subject to repair/retest charges. A purchase order or credit card number and authorization must be provided in order to obtain an RMA (Return Merchandise Authorization) number prior to returning Product.

How to obtain an RMA (Return Merchandise Authorization)

If you need to return a product for warranty or non-warranty repair, you must first obtain an RMA number. Please contact Sealevel Systems, Inc. Technical Support for assistance:

Available	Monday – Friday, 8:00AM to 5:00PM EST
Phone	864-843-4343
Email	support@sealevel.com

Trademarks

Sealevel Systems, Incorporated acknowledges that all trademarks referenced in this manual are the service mark, trademark, or registered trademark of the respective company.